

Pièces de rechange

Spare parts list

Ersatzteilliste

Catalogo Pezzi di Ricambio



CHARRUE SEMI-PORTEE
SEMI MOUNTED REVERSIBLE PLOUGH

AUFSATTELPFLUG

Замовлення запчастин

ARATRO SEMI PORTATO
(050)-407-68-47

(050)-407-68-45

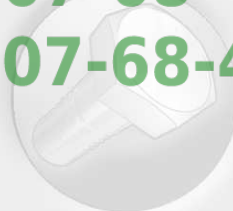

C0000 >

MULTI-LEADER T





Замовлення запчастин

(050)-407-68-47

(050)-407-68-45



SIGNES CODIFIÉS - STANDARD SYMBOLS - SYMBOLE - SIMBOLI CODIFICATI

OPT	Équipement optionnel
STD	Équipement livré de série
ESP	Équipement livré suivant pays
:	Pour ...
>	De ... à ...
RPL	Remplace ...
∅	Diamètre
> <	Épaisseur
<->	Longueur
<m>	Vendu au mètre
Q?	Quantité selon besoin
*	Voir note
[n]	Composant d'un assemblage
+ [n]	Assemblage comprenant les pièces [n]
<-]	Pièce gauche
[->	Pièce droite

OPT	Optional equipment
STD	Equipment supplied as standard
ESP	Equipment supplied for specific countries
:	For ...
>	From ... to ...
RPL	Replaces ...
∅	Diameter
> <	Thickness
<->	Length
<m>	Sold by the metre
Q?	Quantity as required
*	See note
[n]	Items making up assembly
+ [n]	Assembly made up by items [n]
<-]	Left part
[->	Right part

OPT	Sonderausrüstung
STD	Serienausrüstung
ESP	Länderabhängige Ausrüstung
:	Für ...
>	Von ... bis ...
RPL	Ersetzt ...
∅	Durchmesser
> <	Stärke
<->	Länge
<m>	Meterware
Q?	Stückzahl nach Bedarf
*	Siehe Nota
[n]	Teil einer Baugruppe
+ [n]	Baugruppe bestehend aus den mit [n] bezeichneten Teilen
<-]	Links Teil
[->	Rechts Teil

OPT	Attrezzatura opzionale
STD	Attrezzatura fornita di serie
ESP	Attrezzatura fornita secondo il paese
:	Per ...
>	Da ... A ...
RPL	Sostituisce ...
∅	Diametro
> <	Spessore
<->	Lunghezza
<m>	venduto a metro
Q?	Quantità richiesta
*	Vedi nota
[n]	Componente di un assieme
+ [n]	Assieme comprendente i componenti [n]
<-]	Sx componente
[->	Dx componente

POUR COMMANDER DES PIÈCES DE RECHANGE, VEUILLEZ INDIQUER:

- Le numéro de fabrication de la machine
- Le numéro de la pièce
- La quantité désirée

WHEN ORDERING SERVICE-PARTS, WILL YOU PLEASE MENTION:

- The machine type and serial number
- The part number
- The quantity of parts

BEI DER BESTELLUNG VON ERSATZTEILEN IMMER ANGEBEN:

- Die Seriennummer der Maschine
- Die Nummer des Teiles
- Die gewünschte Stückzahl

NELL'ORDINARE I RICAMBI, SI PREGA DI INDICARE:

- Il tipo ed il numero di serie della macchina
- Il codice del componente
- La quantità desiderata

- Toutes les pièces détachées et sous-ensembles sont à commander au magasin pièces de rechange.
- **Les équipements optionnels (OPT)** ainsi que les **notices d'instructions** sont à commander auprès des **services commerciaux**.
- Service parts and service part assemblies are to be ordered through the spare parts department.
- **Optional equipment (OPT)** and **assembly operator's manuals** should be ordered through the **wholegood sales department**.
- Bestellungen für Ersatzteile und Baugruppen sind an die Ersatzteilabteilung zu richten.
- **Sonderausrüstungen (OPT)** sowie **Montage- und Betriebsanleitungen**, bestellen Sie bitte bei der **Verkaufsabteilung für Maschinen**.
- I ricambi e i sotto-assiemi devono essere ordinati al Magazzino Ricambi.
- **Le attrezzature opzionali (OPT)** ed i **manuali dell'operatore** devono essere ordinati al **Servizio Commerciale**.

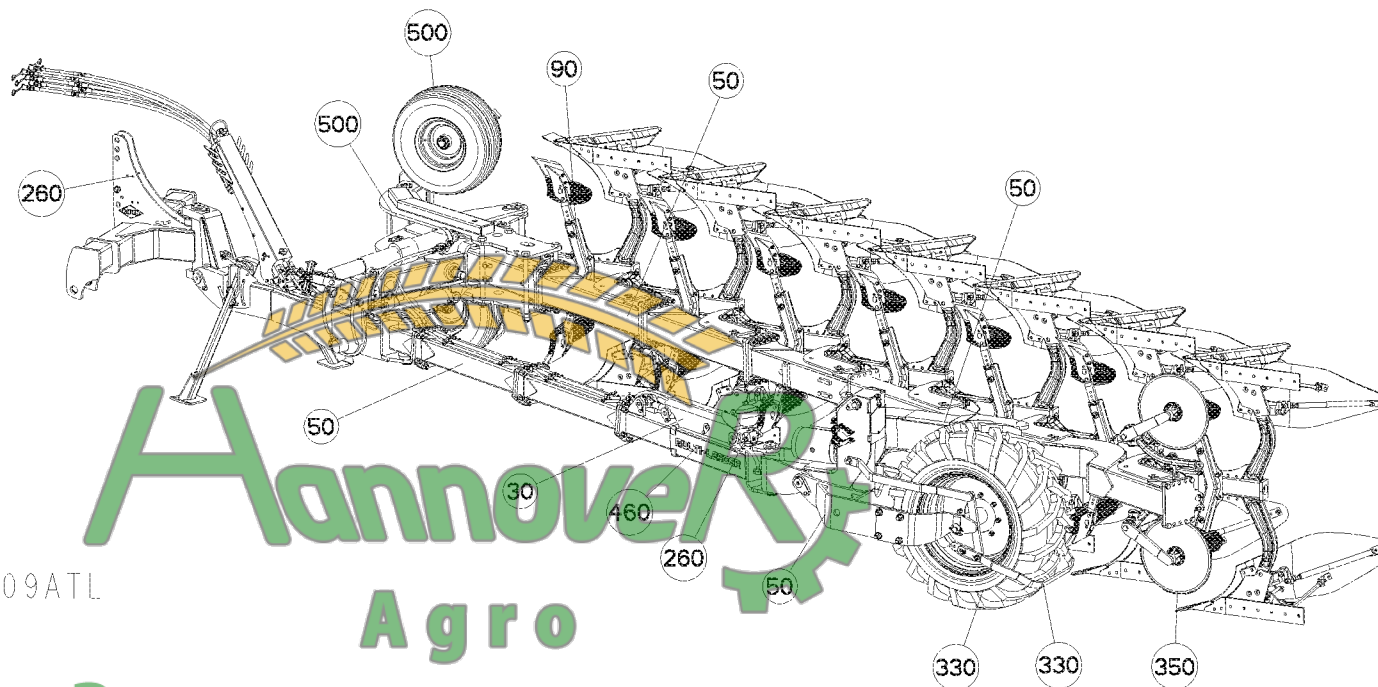

CATALOG. / LIST N°HR009ATL

Агро

Замовлення запчастин

(050)-407-68-47

(050)-407-68-45

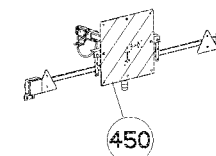



TABLE DES MATIERES - TABLE OF CONTENTS - INHALTSVERZEICHNIS - INDICE

H10R0008 D

Catalogue P.D.R. - Spare parts list - Ersatzteilliste - Pezzi di Ricambio :

HR032BTL C

Grp	Page	Opt	Groupe de pièces	Parts group index	Teilegruppe	Gruppo di parti
010	003		ATTELAGE STD3	CONNECTING FRAME STD3	ANBAUBOCK STD3	ATTACCO STD3
010	005		ATTELAGE STD4/4N	CONNECTING FRAME STD4/4N	ANBAUBOCK STD4/4N	ATTACCO STD4/4N
010	007		ATTELAGE STD K700	CONNECTING FRAME STD K700	ANBAUBOCK STD K700	ATTACCO STD K700
010	009		ATTELAGE STD QC	CONNECTING FRAME STD QC	ANBAUBOCK STD QC	ATTACCO STD QC
020	011		AVANT-TRAIN LEADER	HEADSTOCK LEADER	PFLUGKOPF LEADER	TESTA DI ROTAZIONE LEADER
020	013		AVANT-TRAIN VLD/MLD	HEADSTOCK VLD/MLD	PFLUGKOPF VLD/MLD	TESTA DI ROTAZIONE VLD/MLD
020	015		SUPPORT (FLEXIBLES HYDRAULIQUE	SUPPORT (HYDRAULIC HOSES)	HALTERUNG (HYDRAULIKSCHLAEUCHE	SUPPORTO (TUBI FLESSIBILI IDRA
020	017		RETOURNEMENT	TURNOVER	DREHUNG	RIBALTAMENTO
020	019		RETOURNEMENT	TURNOVER	DREHUNG	RIBALTAMENTO
020	021		RETOURNEMENT	TURNOVER	DREHUNG	RIBALTAMENTO
260	023		HYDRAULIQUE RETOURNEMENT	HYDRAULIC TURNOVER	HYDRAULIK DREHUNG	IDRAULICO RIBALTAMENTO
050	025		TIMON MLD	DRAWBAR MLD	DEICHEL MLD	TIMONE MLD
050	027		TIMON VLD	DRAWBAR VLD	DEICHEL VLD	TIMONE VLD
050	029		EXTENSION (TIMON)	EXTENSION (DRAWBAR)	ERWEITERUNG (DEICHEL)	PROLUNGA (TIMONE)
030	031		DEPORT MÉCANIQUE	MECHANICAL OFFSET	MECH. VORDERFURCHENEINSTELLUNG	SFALSAMENTO MECCANICO
030	033		DEPORT HYDRAULIQUE	HYDRAULIC OFFSET	HYDR. VORDERFURCHEINSTELLUNG	SFALSAMENTO IDRAULICO
030	035	OPT	INDICATEUR DE POSITION (DEPORT	POSITION INDICATOR (OFF SETTIN	STELLUNGSANZEIGE (VERSATZSTUEC	INDICATORE DI POSIZIONE (SFALS
030	037	OPT	INDICATEUR DE POSITION DEPORT	POSITION INDICATOR OFF SETTING	STELLUNGSANZEIGE VERSATZSTUECK	INDICATORE DI POSIZIONE SFALSA
050	039		STRUCTURE MLD	STRUCTURE MLD	STRUKTURTEILE MLD	STRUTTURA MLD
050	041		EXTENSION MEDIANE	MIDDLE EXTENSION	MITTEL ERWEITERUNG	ESTENSIONE CENTRALE
050	043		SUPPORT DE ROUE MLD	WHEEL SUPPORT MLD	RADHALTERUNG MLD	SUPPORTO RUOTA MLD
050	045		SUPPORT DE ROUE MLD	WHEEL SUPPORT MLD	RADHALTERUNG MLD	SUPPORTO RUOTA MLD
050	047		SUPPORT DE ROUE MLD VLD	WHEEL SUPPORT MLD VLD	RADHALTERUNG MLD VLD	SUPPORTO RUOTA MLD VLD
260	049		HYDRAULIQUE DE RELEVAGE	LIFTING HYDRAULIC	HYDRAULIKELEMENTE AUSHEBUNG	SIST. IDRAULICO SOLLEVAMENTO
260	051		HYDRAULIQUE DE RELEVAGE	LIFTING HYDRAULIC	HYDRAULIKELEMENTE AUSHEBUNG	SIST. IDRAULICO SOLLEVAMENTO
260	053		HYDRAULIQUE DE RELEVAGE	LIFTING HYDRAULIC	HYDRAULIKELEMENTE AUSHEBUNG	SIST. IDRAULICO SOLLEVAMENTO
330	055		ROUE 500/45X22,5 14PR	WHEEL 500/45X22,5 14PR	RAD 500/45X22,5 14PR	RUOTA 500/45X22,5 14PR
330	057	OPT	ROUE D1200-500	WHEEL D1200-500	RAD D1200-500	RUOTA D1200-500
330	059	OPT	DECROTTOIR	SCRAPER	ABSTREIFER	POLITIRE
090	061		BOITIER T	BOX T	GEHAEUSE T	SCATOLA T
090	063		AGE SECURITE T80 Q12.9	PLOUGH LEG SAFETY T80 Q12.9	GRINDEL STEINSICHERUN T80 Q12.	BURE DI SICUREZZA T80 Q12.9
090	065	OPT	AGE SECURITE T80 LOS Q12.9	PLOUGH LEG SAFETY T80 LOS Q12.	GRINDEL STEINSICHERUN T80 LOS	BURE DI SICUREZZA T80 LOS Q12.
090	067	OPT	BOITIER TIGES RASETTE	SKIMMER LEG/SUPPORT	HALTERUNG/VORSCHALESTIEL	GAMBO DEL PREVOMERE
350	069	OPT	COUTRE CIRCULAIRE Ø500 T	DISC COULTER Ø500 T	SCHEIBENSECH Ø500 T	ASSOLCATORE A DISCO Ø500 T
350	071	OPT	COUTRE CIRCULAIRE Ø600 T	DISC COULTER Ø600 T	SCHEIBENSECH Ø600 T	ASSOLCATORE A DISCO Ø600 T
500	073	OPT	BRAS OUTIL TRAINÉ MLD	FURROW PRESS ARM MLD	PACKERARM MLD	SOTTOCOMPRESSORE BRACCIO MLD
500	075	OPT	SUPPORT ON-LAND	SUPPORT ON-LAND	HALTERUNG ON-LAND	SUPPORTO ON-LAND
500	079	OPT	ROUE DE PROFONDEUR Ø690X250	DEPTH WHEEL Ø690X250	TASTRAD Ø690X250	RUOTA DI PROFONDITA' Ø690X250
260	081	OPT	SELECTEUR ELECTROHYDR.4 FONC.	ELECTROHYDR.SELECTOR 4 FUNCT.	ELECTROHYDR.SELECTOR 4 FUNKT.	ELECTROIDRA.SELETTORE 4 FUNZ.
260	083	OPT	ELECTROVANNE	ELEKTROSWITCH	ELEKTROWAHLSCHALTUNG	ELETTROINTERRUTTORE

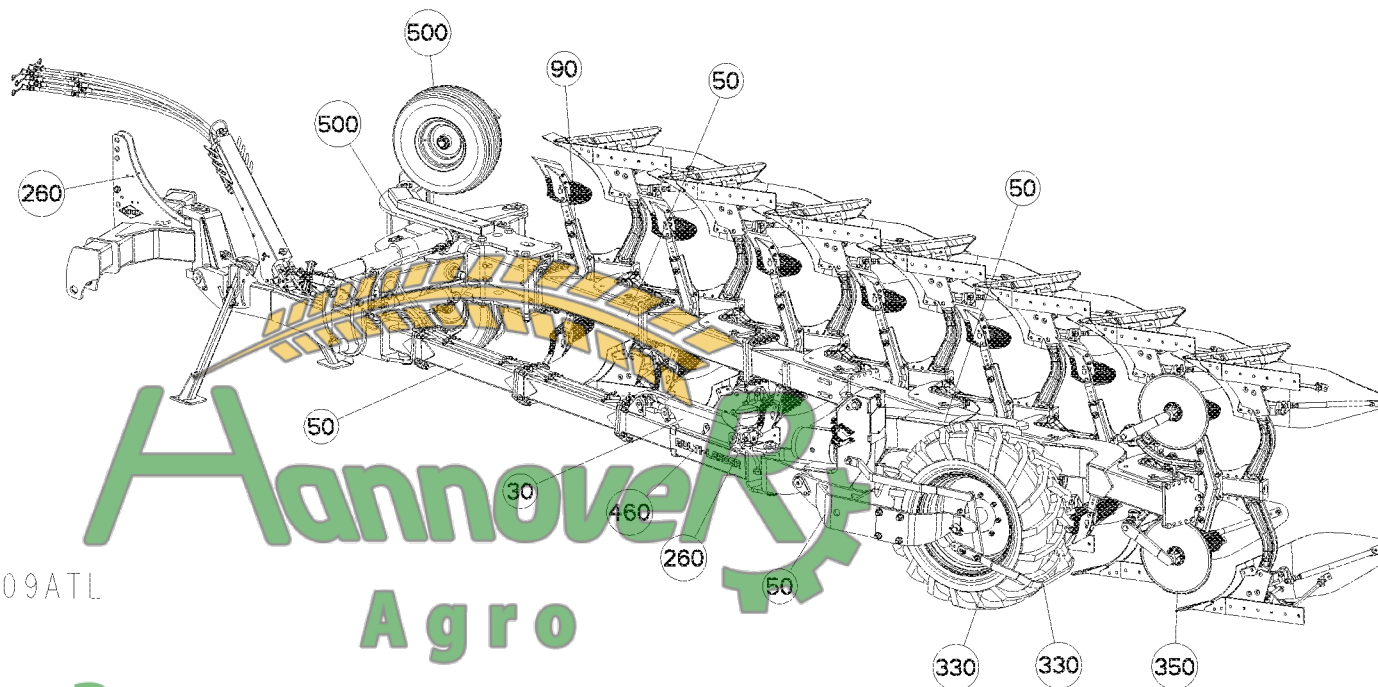

CATALOG. / LIST N°HR009ATL

Агро

Замовлення запчастин

(050)-407-68-47

(050)-407-68-45

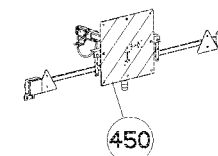



TABLE DES MATIERES - TABLE OF CONTENTS - INHALTSVERZEICHNIS - INDICE

H10R0008 D

Catalogue P.D.R. - Spare parts list - Ersatzteilliste - Pezzi di Ricambio :

HR032BTL C

Grp	Page	Opt	Groupe de pièces	Parts group index	Teilegruppe	Gruppo di parti
260	085	OPT	ELECTROVANNE	ELEKTROSWITCH	ELEKTROWAHLSCHALTUNG	ELETTROINTERRUTTORE
450	087	OPT	RAMPE DE SIGNALISATION T	T REAR LIGHTING BOARD	T HECKBELEUCHTUNG FÜR TRANSPOR	IMPIANTO TRASPORTO
450	089	OPT	FAISCEAU ELECTRIQUE SIGNALISAT	WIRING HARNESS SIGNALLING	KABELBAUM BELEUCHTUNG U.WARNTA	CABLAGGIO SEGNALAZIONE
260	091	OPT	COUPLEURS HYDRAULIQUES RUSSE	HYDRAULIC COUPLERS RUSSE	HYDRAULIKANSCHLUESSE RUSSE	CONNETTORI IDRAULICI RUSSE
460	093		ETIQUETTES ADHESIVES MLD T	STICKERS MLD T	AUFKLEBER MLD T	ADESIVI MLD T
480	095	OPT	SUPPORT (CLEE)	SUPPORT (KEY)	HALTERUNG (SCHLUSSEL)	SUPPORTO (##KEY)
480	097		OUTILLAGE	TOOLS	WERKZEUG	ATTREZZI



Замовлення запчастин

(050)-407-68-47

(050)-407-68-45





ATTELAGE STD3

CONNECTING FRAME STD3

ANBAUBOCK STD3

ATTACCO STD3

Rep	Nr	Qt	Designation	Description	Bezeichnung	Referenza	Remarque - Remark - Bemerkung - Osservazioni
001	541001	001	GOUPILLE RAPIDE	LYNCH PIN D10 CAT2	KLAPPSTECKER D10 KAT2	CAPPIGLIA	
002	80252432	001	RONDELLE PLATE FE/ZNXC3	PLAIN WASHER FE/ZNXC3	SCHEIBE FE/ZNXC3	RONDELLA PIATTA FE/ZNXC3	
003	80561760	002	GOUPILLE AUTOMATIQUE	LINCH PIN	KLAPPSTECKER	COPPIGLIA	
004	H0100630	002	TOURILLON	TRUNNION	DREHZAPFEN	ASSE	
005	H0101220	001	BROCHE	PIN, HITCH	ACHSE	PERNO	
006	H0102980	002	ENTRETOISE	SPACER	DISTANZHUELSE	DISTANZIALE	



Замовлення запчастин

(050)-407-68-47

(050)-407-68-45



Hannover
Agro

Замовлення запчастин
(050)-407-68-47
(050)-407-68-45



1: A small circular component, possibly a bearing or roller, with a central hole and a textured outer surface.

2: A small circular component, similar to part 1, but with a different internal structure.

3: A U-shaped component, possibly a bracket or a part of a roller assembly.

4: A long, cylindrical shaft with a central hole and a slightly wider section in the middle.

5: A small cylindrical component with a central hole and a textured outer surface.

6: A small cylindrical component with a central hole and a textured outer surface, similar to part 5.



ATTELAGE STD4/4N

CONNECTING FRAME STD4/4N

ANBAUBOCK STD4/4N

ATTACCO STD4/4N

Rep	Nr	Qt	Designation	Description	Bezeichnung	Referenza	Remarque - Remark - Bemerkung - Osservazioni
001	541001	001	GOUPILLE RAPIDE	LYNCH PIN D10 CAT2	KLAPPSTECKER D10 KAT2	CAPPIGLIA	
002	80252432	001	RONDELLE PLATE FE/ZNXC3	PLAIN WASHER FE/ZNXC3	SCHEIBE FE/ZNXC3	RONDELLA PIATTA FE/ZNXC3	
003	80561760	002	GOUPILLE AUTOMATIQUE	LINCH PIN	KLAPPSTECKER	COPPIGLIA	
004	H0100630	002	TOURILLON	TRUNNION	DREHZAPFEN	ASSE	
005	H0101220	001	BROCHE	PIN, HITCH	ACHSE	PERNO	
006	H0102990	002	ENTRETOISE	SPACER	DISTANZHUELSE	DISTANZIALE	



Замовлення запчастин

(050)-407-68-47

(050)-407-68-45



Замовлення запчастин
(050)-407-68-47
(050)-407-68-45

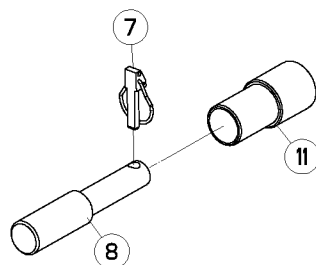
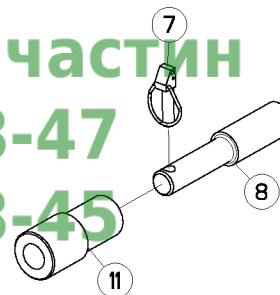



ATTELAGE STD K700

CONNECTING FRAME STD K700

ANBAUBOCK STD K700

ATTACCO STD K700

Rep	Nr	Qt	Designation	Description	Bezeichnung	Referenza	Remarque - Remark - Bemerkung - Osservazioni
001	130276	001	AXE	PIN	ACHSE	ASSE	
002	421138	002	BAGUE	BUSHING	HUELSE	BOCCOLA	
003	445556	002	ENTRETOISE	SPACER	DISTANZHUELSE	DISTANZIALE	
004	900788	001	GOUPILLE DE SECURITE	LYNCH PIN	KLAPPSTECKER	COPPIGLIA	
005	80062494	002	VIS TETE HEXAGONALE FE/ZNXC3	HEXAGON HEAD SCREW FE/ZNXC3	SECHSKANTSCHRAUBE FE/ZNXC3	VITE TESTA ESAGONALE FE/ZNXC3	
006	80202442	002	ECROU HEX.BAS AUTOFR.FE/ZNXC3	SELF-LOCKING NUT FE/ZNXC3	SELBSTSICHERND.MUTTER FE/ZNXC3	DADO AUTOBLOCCANTE FE/ZNXC3	
007	80561760	002	GOUPILLE AUTOMATIQUE	LINCH PIN	KLAPPSTECKER	COPPIGLIA	
008	H0100630	002	TOURILLON	TRUNNION	DREHZAPFEN	ASSE	
009	H0101750	001	JOUE DE CHAPE	CLEVIS, HALF	ZUGMAULHELFTE	GUIDA	
010	H0101760	001	JOUE DE CHAPE	CLEVIS, HALF	ZUGMAULHELFTE	GUIDA	
011	H0103000	002	ENTRETOISE	SPACER	DISTANZHUELSE	DISTANZIALE	



Замовлення запчастин

(050)-407-68-47

(050)-407-68-45



Замовлення запчастин

(050)-407-68-47

(050)-407-68-45

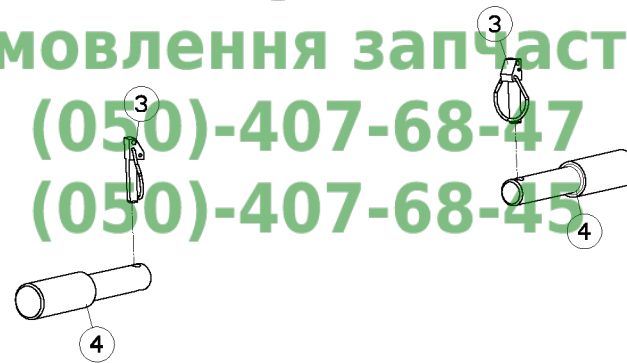



MULTI-LEADER T

C0000 >

H01R0115 B

ATTELAGE STD QC

CONNECTING FRAME STD QC

ANBAUBOCK STD QC

ATTACCO STD QC

Rep	Nr	Qt	Designation	Description	Bezeichnung	Referenza	Remarque - Remark - Bemerkung - Osservazioni
001	541001	001	GOUPILLE RAPIDE	LYNCH PIN D10 CAT2	KLAPPSTECKER D10 KAT2	CAPPIGLIA	
002	80252432	001	RONDELLE PLATE FE/ZNXC3	PLAIN WASHER FE/ZNXC3	SCHEIBE FE/ZNXC3	RONDELLA PIATTA FE/ZNXC3	
003	80561760	002	GOUPILLE AUTOMATIQUE	LINCH PIN	KLAPPSTECKER	COPPIGLIA	
004	H0100630	002	TOURILLON	TRUNNION	DREHZAPFEN	ASSE	
005	H0101220	001	BROCHE	PIN, HITCH	ACHSE	PERNO	



Замовлення запчастин

(050)-407-68-47

(050)-407-68-45

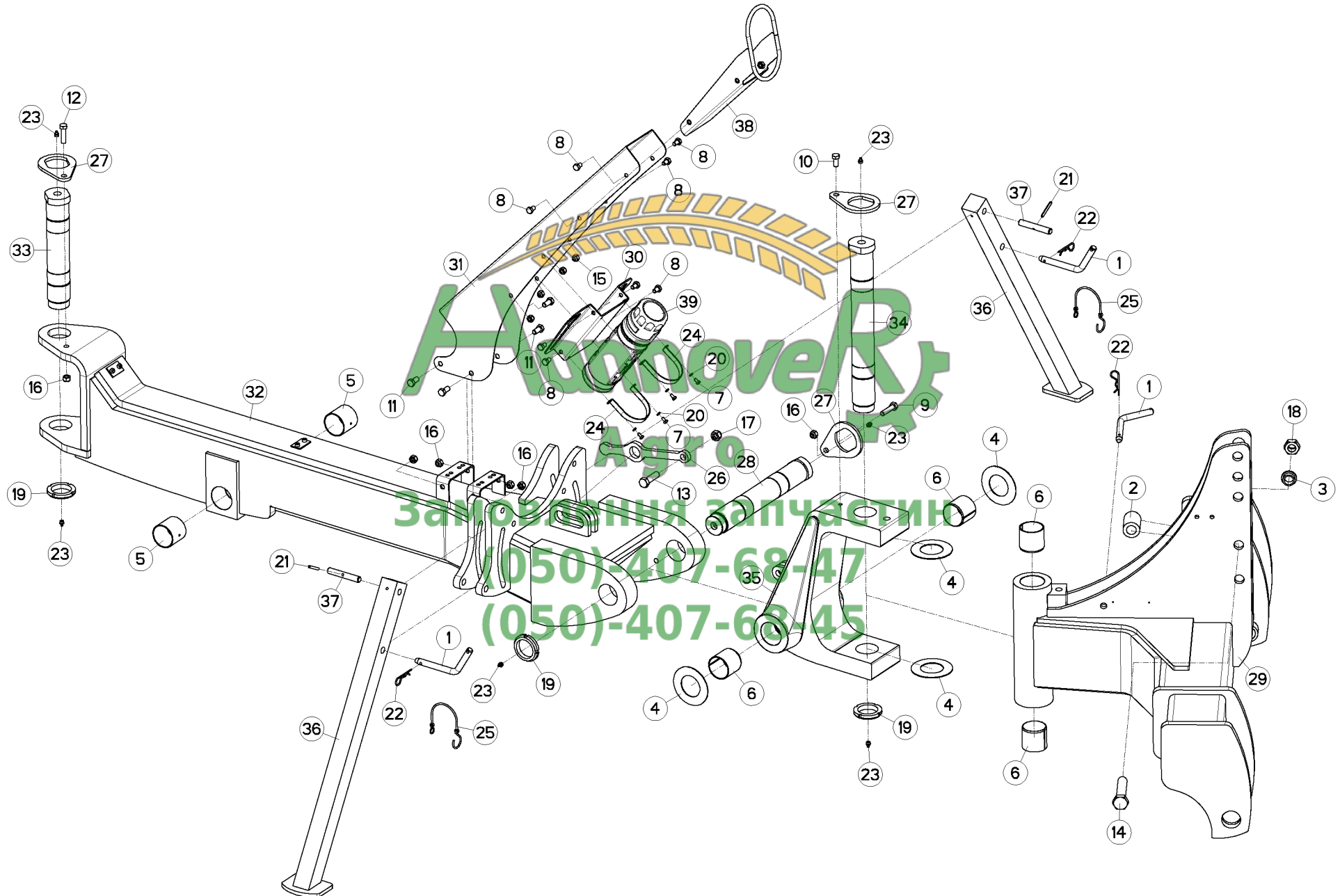



AVANT-TRAIN LEADER

HEADSTOCK LEADER

PFLUGKOPF LEADER

TESTA DI ROTAZIONE LEADER

Rep	Nr	Qt	Designation	Description	Bezeichnung	Referenza	Remarque - Remark - Bemerkung - Osservazioni
001	139113	003	BROCHE	PIN, HITCH	ACHSE	PERNO	
002	445556	001	ENTRETOISE	SPACER	DISTANZHUELSE	DISTANZIALE	
003	445609	001	BAGUE	BUSHING	HUELSE	BOCCOLA	
004	900742	004	BAGUE ANTI-FRICTION	ANTI-FRICTION BUSHES	VERSCHLEISSRING	BOCCOLA	
005	951448	002	BAGUE ROULEE	WRAPPED BUSH	GEROLLTE BUCHSE MESSING	ANELLO LUBRIFICATO	
006	951521	004	BAGUE ELASTIQUE	TENSION BUSH	EINSPANNBUECHSE	SPINA ELASTICA	
007	80060612	004	VIS TETE HEXAGONALE FE/ZNXC3	HEXAGON HEAD SCREW FE/ZNXC3	SECHSKANTSCHRAUBE FE/ZNXC3	VITE TESTA ESAGONALE FE/ZNXC3	
008	80061018	008	VIS TETE HEXAGONALE INOX	HEXAGON HEAD SCREW INOX	SECHSKANTSCHRAUBE INOX	VITE A TESTA ESAGONALE INOX	
009	80061291	001	VIS TETE HEXAGONALE FLZNNC	HEXAGON HEAD SCREW FLZNNC	SECHSKANTSCHRAUBE FLZNNC	VITE A TESTA ESAGONALE FLZNNC	
010	80061225	001	VIS TETE HEXAGONALE FE/ZNXC3	HEXAGON HEAD SCREW FE/ZNXC3	SECHSKANTSCHRAUBE FE/ZNXC3	VITE TESTA ESAGONALE FE/ZNXC3	
011	80061226	004	VIS TETE HEXAGONALE INOX	HEXAGON HEAD SCREW INOX	SECHSKANTSCHRAUBE INOX	VITE A TESTA ESAGONALE INOX	
012	80061245	001	VIS TETE HEXAGONALE FE/ZNXC3	HEXAGON HEAD SCREW FE/ZNXC3	SECHSKANTSCHRAUBE FE/ZNXC3	VITE TESTA ESAGONALE FE/ZNXC3	
013	80061651	001	VIS TETE HEXAGONALE FE/ZNXC3	HEXAGON HEAD SCREW FE/ZNXC3	SECHSKANTSCHRAUBE FE/ZNXC3	VITE TESTA ESAGONALE FE/ZNXC3	
014	80062489	001	VIS TETE HEXAGONALE FE/ZNXC3	HEXAGON HEAD SCREW FE/ZNXC3	SECHSKANTSCHRAUBE FE/ZNXC3	VITE TESTA ESAGONALE FE/ZNXC3	
015	80201030	004	ECROU HEX.AUTOFREINE FE/ZNXC3	SELF-LOCKING NUT FE/ZNXC3	SELBSTSICH.MUTTER FE/ZNXC3	DADO AUTOBLOCCANTE FE/ZNXC3	
016	80201240	006	ECROU HEX.BAS AUTOFR.FE/ZNXC3	SELF-LOCKING NUT FE/ZNXC3	SELBSTSICHERND.MUTTER FE/ZNXC3	DADO AUTOBLOCCANTE FE/ZNXC3	
017	80201640	001	ECROU HEX.BAS AUTOFR.FE/ZNXC3	SELF-LOCKING NUT FE/ZNXC3	SELBSTSICHERND.MUTTER FE/ZNXC3	DADO AUTOBLOCCANTE FE/ZNXC3	
018	80202442	001	ECROU HEX.BAS AUTOFR.FE/ZNXC3	SELF-LOCKING NUT FE/ZNXC3	SELBSTSICHERND.MUTTER FE/ZNXC3	DADO AUTOBLOCCANTE FE/ZNXC3	
019	80205566	003	ECROU A ENCOCH.AUTOF.FE/ZNXC3	SELF-LOCKING NUT FE/ZNXC3	SELBSTSICHERN.MUTTER FE/ZNXC3	DADO AUTOBLOCCANTE FE/ZNXC3	
020	80270605	004	RONDELLE GROWER FE/ZNXC3	SPRING LOCK WASHER FE/ZNXC3	FEDERRING FE/ZNXC3	RONDELLA GROWER FE/ZNXC3	
021	80450650	002	GOUPILLE ELASTIQUE FLZNNC	ROLL PIN FLZNNC	SPANNHUELSE FLZNNC	SPINA ELASTICA FLZNNC	
022	80570300	003	GOUPILLE BETA SIMPLE FE/ZNXC3	SPRING COTTER PIN FE/ZNXC3	FEDERSTECKER FE/ZNXC3	MOLLA FE/ZNXC3	
023	82201016	006	GRAISSEUR AUTOTARAUDANT	SELF TAPPING GREASE NIPPLE	GEWINDESCHNEID-SCHMIERNIPPEL	INGRASSATORE	
024	83090596	002	COLLIER	CLAMP, HOSE	SCHLAUCHSCHELLE	COLLARE	
025	83070064	002	LIEN PVC	PVC CORD	SICHERUNGSBAND	CAVO	
026	H0100170	001	BIELLETTA	LINK	SHUBSTANGE	BIELLETTA	
027	H0100350	003	PLAQUETTE ARRETOIR	STOP PLATE	ARRETIERUNGSBLECH	PLACHETTA	
028	H0103010	001	AXE	PIN	ACHSE	ASSE	
029	H0103470	001	POTENCE	BOOM	TRAGARM	ATTACCO ATTREZZO	
030	H0103600	001	SUPPORT	SUPPORT	TRAEGER	SUPPORTO	
031	H0103610	001	RAMPE	BOOM, SPRAYER	RAMPE	BARRA	
032	H0103780	001	CHAPE	CLEVIS	GABEL	FORCELLA	
033	H0104010	001	AXE	PIN	ACHSE	ASSE	
034	H0104020	001	AXE	PIN	ACHSE	ASSE	
035	H0104710	001	CARDAN	JOINT, UNIVERSAL	KREUZGELENK	CARDANO	
036	H0206290	002	BEQUILLE	STAND	STAENDER	SUPPORTO	
037	H0206300	002	AXE	PIN	ACHSE	ASSE	
038	K2502911	001	SUPPORT	SUPPORT	TRAEGER	SUPPORTO	
039	K7024100	001	BOITE	BOX	KASTEN	SCATOLA	

Автомобильная часть
 (050)-207-58-47
 (050)-407-68-45





AVANT-TRAIN VLD/MLD

HEADSTOCK VLD/MLD

PFLUGKOPF VLD/MLD

TESTA DI ROTAZIONE VLD/MLD

Rep	Nr	Qt	Designation	Description	Bezeichnung	Referenza	Remarque - Remark - Bemerkung - Osservazioni
001	H0103011	001	AXE	PIN	ACHSE	ASSE	
002	H0104010	001	AXE	PIN	ACHSE	ASSE	
003	H0104021	001	AXE	PIN	ACHSE	ASSE	
004	H0206300	002	AXE	PIN	ACHSE	ASSE	
005	900742	004	BAGUE ANTI-FRICTION	ANTI-FRICTION BUSHES	VERSCHEISSRING	BOCCOLA	
006	H0302300	004	BAGUE	BUSHING	HUELSE	BOCCOLA	
007	951448	002	BAGUE ROULEE	WRAPPED BUSH	GEROLLTE BUCHSE MESSING	ANELLO LUBRIFICATO	
008	H0206290	002	BEQUILLE	STAND	STAENDER	SUPPORTO	
009	H0100170	001	BIELLETTE	LINK	SHUBSTANGE	BIELLETTA	
010	K7024100	001	BOITE	BOX	KASTEN	SCATOLA	
011	A7250558	002	BOUCHON D'OBTURATION	END PLUG	STOPFEN	TAPPO	
012	139113	002	BROCHE	PIN, HITCH	ACHSE	PERNO	
013	731018	001	BROCHE	PIN, HITCH	ACHSE	PERNO	
014	H0104711	001	CARDAN	JOINT, UNIVERSAL	KREUZGELENK	CARDANO	
015	H0103781	001	CHAPE	CLEVIS	GABEL	FORCELLA	
016	83090596	002	COLLIER	CLAMP, HOSE	SCHLAUCHSCHELLE	COLLARE	
017	H0600650	001	COUVERCLE	LID	DECKEL	COPERCHIO	
018	445609	001	BAGUE	BUSHING	HUELSE	BOCCOLA	
019	80205566	003	ECROU A ENCOCH.AU TOF.FE/ZNXC3	SELF-LOCKING NUT FE/ZNXC3	SELBSTSICHERN.MUTTER FE/ZNXC3	DADO AUTOBLOCCANTE FE/ZNXC3	
020	80201240	008	ECROU HEX.BAS AUTOFR.FE/ZNXC3	SELF-LOCKING NUT FE/ZNXC3	SELBSTSICHERND.MUTTER FE/ZNXC3	DADO AUTOBLOCCANTE FE/ZNXC3	
021	80201640	001	ECROU HEX.BAS AUTOFR.FE/ZNXC3	SELF-LOCKING NUT FE/ZNXC3	SELBSTSICHERND.MUTTER FE/ZNXC3	DADO AUTOBLOCCANTE FE/ZNXC3	
022	80202442	001	ECROU HEX.BAS AUTOFR.FE/ZNXC3	SELF-LOCKING NUT FE/ZNXC3	SELBSTSICHERND.MUTTER FE/ZNXC3	DADO AUTOBLOCCANTE FE/ZNXC3	
023	80201001	004	ECROU HEXAGONAL BAS FE/ZNXC3	NUT FE/ZNXC3	SECHSKANTMUTTER FE/ZNXC3	DADO FE/ZNXC3	
024	445556	001	ENTRETOISE	SPACER	DISTANZHUELSE	DISTANZIALE	
025	H0105090	001	GOULOTTE	CHUTE	AUSLAUF	BOCCA	
026	80570300	003	GOUPILLE BETA SIMPLE FE/ZNXC3	SPRING COTTER PIN FE/ZNXC3	FEDERSTECKER FE/ZNXC3	MOLLA FE/ZNXC3	
027	80450650	002	GOUPILLE ELASTIQUE FLZNNC	ROLL PIN FLZNNC	SPANNHUELSE FLZNNC	SPINA ELASTICA FLZNNC	
028	82201016	006	GRAISSEUR AUTOTARAUDANT	SELF TAPPING GREASE NIPPLE	GEWINDESCHNEID-SCHMIERNIPPEL	INGRASSATORE	
029	83070064	002	LIEN PVC	PVC CORD	SICHERUNGSBAND	CAVO	
030	H0100350	003	PLAQUETTE ARRETOIR	STOP PLATE	ARRETIERUNGSBLECH	PLACHETTA	
031	H0103471	001	POTENCE	BOOM	TRAGARM	ATTACCO ATTREZZO	
032	80270605	004	RONDELLE GROWER FE/ZNXC3	SPRING LOCK WASHER FE/ZNXC3	FEDERRING FE/ZNXC3	RONDELLA GROWER FE/ZNXC3	
033	80251221	006	RONDELLE PLATE INOX A2	PLAIN WASHER INOX A2	SCHEIBE INOX A2	RONDELLA PIATTA INOX A2	
034	H2417650	001	SUPPORT	SUPPORT	TRAEGER	SUPPORTO	
035	80131018	004	VIS AUTOBLOQUANTE	UNDERSERRATED S-LOCKING SCREW	SPERRZAHN-BUNDSCHRAUBE	VITE	
036	80190616	001	VIS A TOLE TETE H FE/ZNXC3	HEXAGON HEAD TAPPING SCREWS	SECHSKANT-BLECHSCHRAUBEN		
037	80060612	004	VIS TETE HEXAGONALE FE/ZNXC3	HEXAGON HEAD SCREW FE/ZNXC3	SECHSKANTSCHRAUBE FE/ZNXC3	VITE TESTA ESAGONALE FE/ZNXC3	
038	80061066	002	VIS TETE HEXAGONALE FE/ZNXC3	HEXAGON HEAD SCREW FE/ZNXC3	SECHSKANTSCHRAUBE FE/ZNXC3	VITE TESTA ESAGONALE FE/ZNXC3	
039	80061225	007	VIS TETE HEXAGONALE FE/ZNXC3	HEXAGON HEAD SCREW FE/ZNXC3	SECHSKANTSCHRAUBE FE/ZNXC3	VITE TESTA ESAGONALE FE/ZNXC3	
040	80061245	001	VIS TETE HEXAGONALE FE/ZNXC3	HEXAGON HEAD SCREW FE/ZNXC3	SECHSKANTSCHRAUBE FE/ZNXC3	VITE TESTA ESAGONALE FE/ZNXC3	
041	80061651	001	VIS TETE HEXAGONALE FE/ZNXC3	HEXAGON HEAD SCREW FE/ZNXC3	SECHSKANTSCHRAUBE FE/ZNXC3	VITE TESTA ESAGONALE FE/ZNXC3	
042	80062489	001	VIS TETE HEXAGONALE FE/ZNXC3	HEXAGON HEAD SCREW FE/ZNXC3	SECHSKANTSCHRAUBE FE/ZNXC3	VITE TESTA ESAGONALE FE/ZNXC3	
043	80061291	001	VIS TETE HEXAGONALE FLZNNC	HEXAGON HEAD SCREW FLZNNC	SECHSKANTSCHRAUBE FLZNNC	VITE A TESTA ESAGONALE FLZNNC	

Агро
 (050)-407-68-47
 (050)-407-68-45





SUPPORT (FLEXIBLES HYDRAULIQUE

SUPPORT (HYDRAULIC HOSES)

HALTERUNG (HYDRAULIKSCHLAEUCHE

SUPPORTO (TUBI FLESSIBILI IDRA

Rep	Nr	Qt	Designation	Description	Bezeichnung	Referenza	Remarque - Remark - Bemerkung - Osservazioni
001	80061236	002	VIS TETE HEXAGONALE FE/ZNXC3	HEXAGON HEAD SCREW FE/ZNXC3	SECHSKANTSCHRAUBE FE/ZNXC3	VITE TESTA ESAGONALE FE/ZNXC3	
002	80201240	002	ECROU HEX.BAS AUTOFR.FE/ZNXC3	SELF-LOCKING NUT FE/ZNXC3	SELBSTSICHERND.MUTTER FE/ZNXC3	DADO AUTOBLOCCANTE FE/ZNXC3	
003	80252026	006	RONDELLE PLATE FE/ZNXC3	PLAIN WASHER FE/ZNXC3	SCHLEIBE FE/ZNXC3	RONDELLA PIATTA FE/ZNXC3	
004	80500470	006	GOUPILLE FENDUE FE/ZNXC3	SPLIT PIN FE/ZNXC3	SPLINT FE/ZNXC3	COPPIGLIA FE/ZNXC3	
005	H0208660	002	TUBE	TUBE	ROHR	TUBO	
006	H0208670	002	AXE	PIN	ACHSE	ASSE	
007	H0208680	001	AXE	PIN	ACHSE	ASSE	
008	H0208690	001	TUBE	TUBE	ROHR	TUBO	
009	H0208700	001	PIED	FOOT	FUSS	PIEDE	
010	H0208710	001	GUIDE	GUIDE	FUEHRUNG	GUIDA	



Замовлення запчастин

(050)-407-68-47

(050)-407-68-45

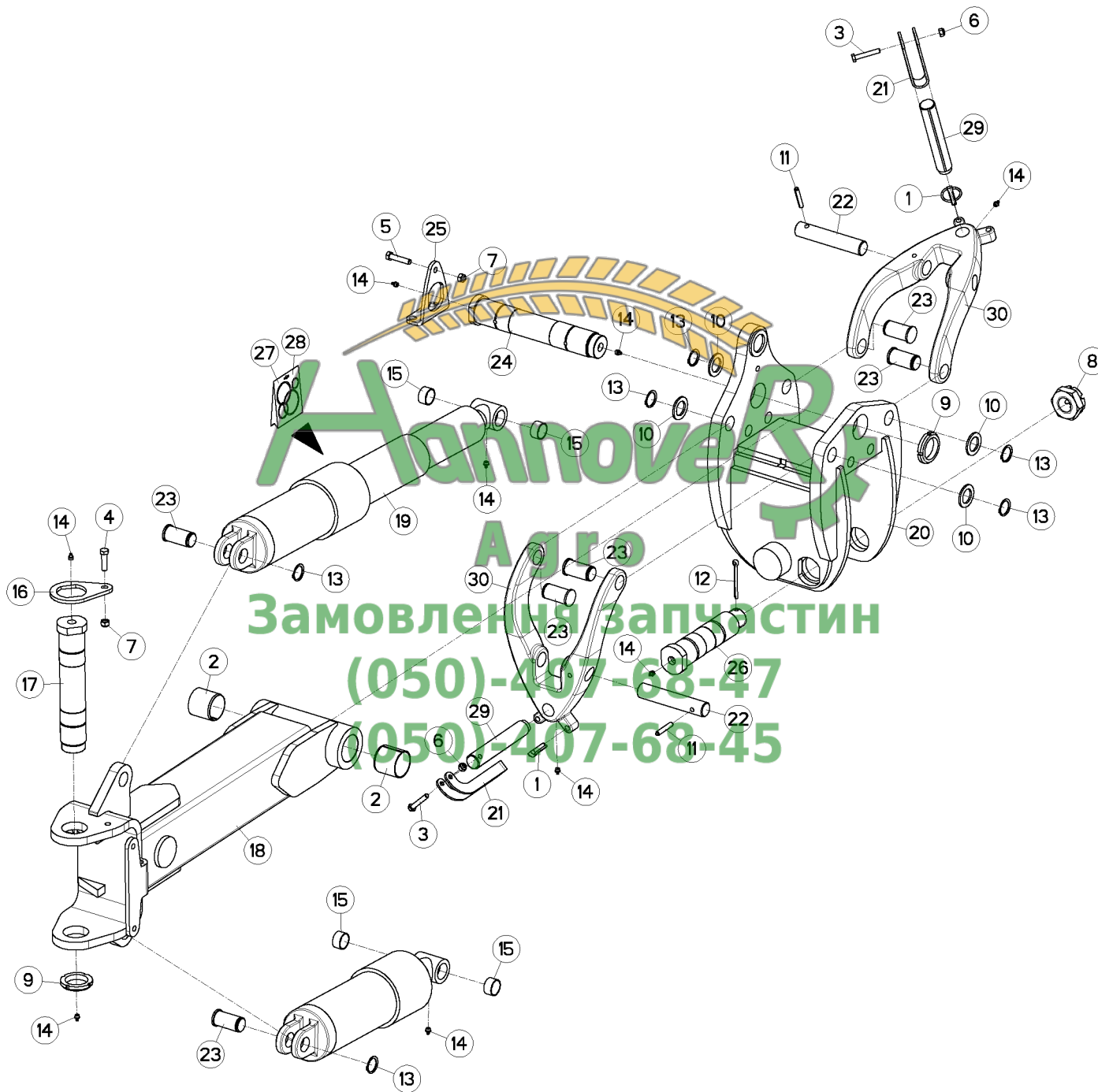



RETOURNEMENT

TURNOVER

DREHUNG

RIBALTAMENTO

Rep	Nr	Qt	Designation	Description	Bezeichnung	Referenza	Remarque - Remark - Bemerkung - Osservazioni
001	541001	002	GOUPILLE RAPIDE	LYNCH PIN D10 CAT2	KLAPPSTECKER D10 KAT2	CAPPIGLIA	
002	951521	002	BAGUE ELASTIQUE	TENSION BUSH	EINSPANNBUCHSE	SPINA ELASTICA	
003	80061054	002	VIS TETE HEXAGONALE FE/ZNXC3	HEXAGON HEAD SCREW FE/ZNXC3	SECHSKANTSCHRAUBE FE/ZNXC3	VITE TESTA ESAGONALE FE/ZNXC3	
004	80061245	001	VIS TETE HEXAGONALE FE/ZNXC3	HEXAGON HEAD SCREW FE/ZNXC3	SECHSKANTSCHRAUBE FE/ZNXC3	VITE TESTA ESAGONALE FE/ZNXC3	
005	80061296	001	VIS TETE HEXAGONALE FE/ZNXC3	HEXAGON HEAD SCREW FE/ZNXC3	SECHSKANTSCHRAUBE FE/ZNXC3	VITE TESTA ESAGONALE FE/ZNXC3	
006	80201030	002	ECROU HEX.AUTOFREINE FE/ZNXC3	SELF-LOCKING NUT FE/ZNXC3	SELBSTSICH.MUTTER FE/ZNXC3	DADO AUTOBLOCCANTE FE/ZNXC3	
007	80201240	002	ECROU HEX.BAS AUTOFR.FE/ZNXC3	SELF-LOCKING NUT FE/ZNXC3	SELBSTSICHERND.MUTTER FE/ZNXC3	DADO AUTOBLOCCANTE FE/ZNXC3	
008	80204518	001	ECROU HK BAS FE/ZNXC3	HEXAGON CASTLE NUT FE/ZNXC3	FLACHE KRONENMUTTER FE/ZNXC3	DADO FE/ZNXC3	
009	80205566	002	ECROU A ENCOCH.AUTOF.FE/ZNXC3	SELF-LOCKING NUT FE/ZNXC3	SELBSTSICHERN.MUTTER FE/ZNXC3	DADO AUTOBLOCCANTE FE/ZNXC3	
010	80253556	004	RONDELLE PLATE FE/ZNXC3	PLAIN WASHER FE/ZNXC3	SCHEIBE FE/ZNXC3	RONDELLA PIATTA FE/ZNXC3	
011	80451061	002	GOUPILLE ELASTIQUE FLZNNC	ROLL PIN FLZNNC	SPANNHUELSE FLZNNC	SPINA ELASTICA FLZNNC	
012	80500780	001	GOUPILLE FENDUE FE/ZNXC3	SPLIT PIN FE/ZNXC3	SPLINT FE/ZNXC3	COPPIGLIA FE/ZNXC3	
013	80583500	006	CIRCLIP EXTERIEUR	RETAINING RING	SICHERUNGSRING	ANELLO	
014	82201016	009	GRAISSEUR AUTOTARAUDANT	SELF TAPPING GREASE NIPPLE	GEWINDESCHNEID-SCHMIERNIPPEL	INGRASSATORE	
015	83013539	004	BAGUE ROULEE	WRAPPED BUSH	GEROLLTE BUCHSE	ANELLO LUBRIFICATO	
016	H0100350	001	PLAQUETTE ARRETOIR	STOP PLATE	ARRETIERUNGSBLECH	PLACHETTA	
017	H0104010	001	AXE	PIN	ACHSE	ASSE	
018	H0204720	001	BOITIER	HOUSING	GEHAEUSE	SCATOLA	
019	H0204740	002	VERIN	CYLINDER, HYDRAULIC	HYDRAULIKZYLINDER	CILINDRO	
020	H0204780	001	CHAPE	CLEVIS	GABEL	FORCELLA	
021	H0204940	002	POIGNEE	HANDLE	HANDGRIFF	MANIGLIA	
022	H0204990	002	AXE	PIN	ACHSE	ASSE	
023	H0205000	006	AXE	PIN	ACHSE	ASSE	
024	H0205020	001	AXE	PIN	ACHSE	ASSE	
025	H0206040	001	PLAQUETTE	PLATE	PLATTE		
026	H0206480	001	AXE	PIN	ACHSE	ASSE	
027	H0206650	001	POCHETTE	KIT, SEAL	TACHE	SACCHE	: H0206640
028	H0206670	001	POCHETTE	KIT, SEAL	TACHE	SACCHE	: H0206660
029	H2207650	002	VIS	SCREW	SCHRAUBE	VITE	
030	H0204980	002	BIELLETTTE	LINK	SUBSTANGE		

Harvester
 Агро
 Zamovleniya zapchastey
 (050)-407-68-47
 (050)-407-68-45

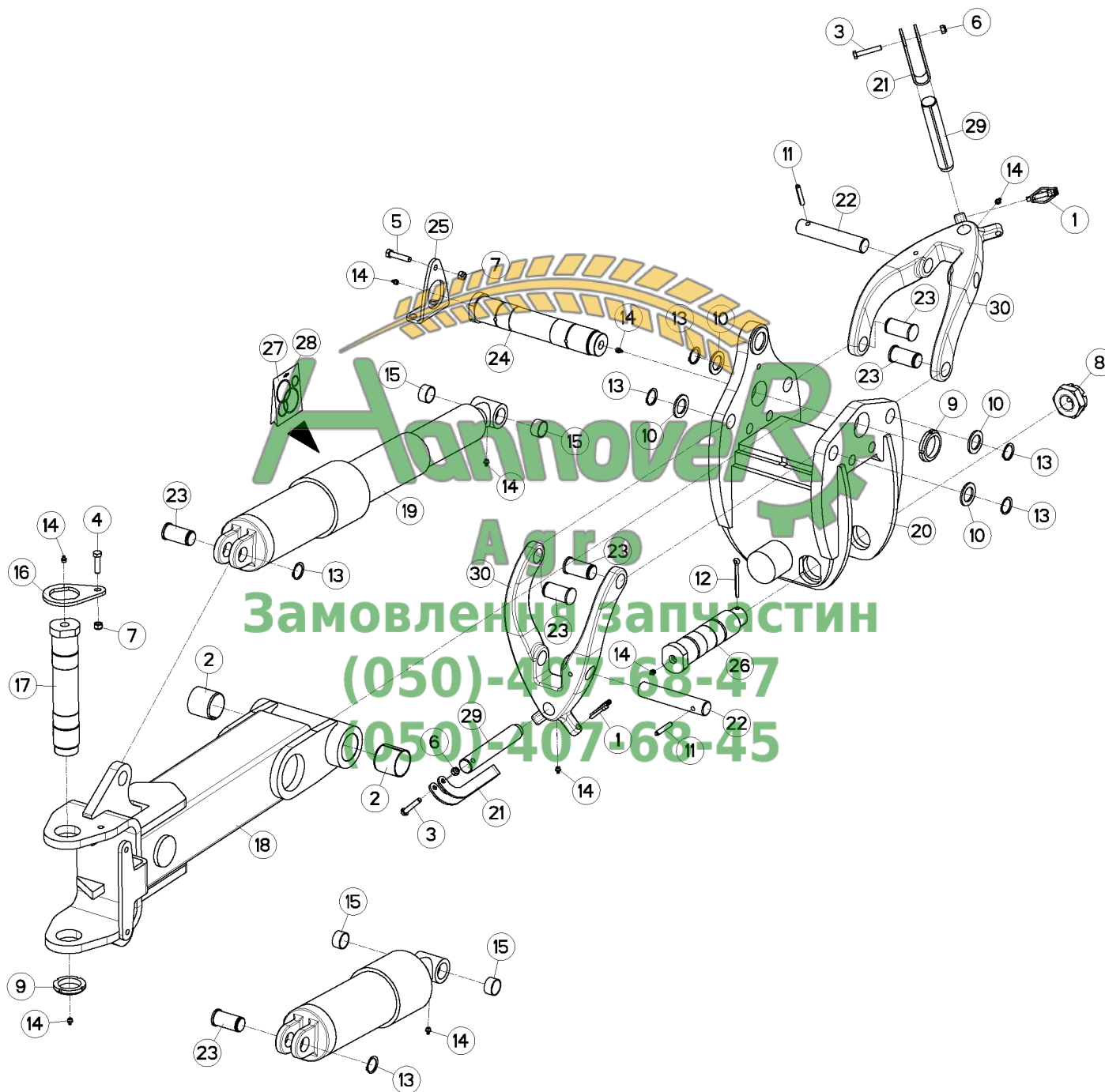



RETOURNEMENT

TURNOVER

DREHUNG

RIBALTAMENTO

Rep	Nr	Qt	Designation	Description	Bezeichnung	Referenza	Remarque - Remark - Bemerkung - Osservazioni
001	951408	002	GOUPILLE A RESSORT	LYNCH PIN	KLAPPSTECKER	COPPIGLIA DI SICUREZZA	
002	951521	002	BAGUE ELASTIQUE	TENSION BUSH	EINSPANNBUCHSE	SPINA ELASTICA	
003	80061054	002	VIS TETE HEXAGONALE FE/ZNXC3	HEXAGON HEAD SCREW FE/ZNXC3	SECHSKANTSCHRAUBE FE/ZNXC3	VITE TESTA ESAGONALE FE/ZNXC3	
004	80061245	001	VIS TETE HEXAGONALE FE/ZNXC3	HEXAGON HEAD SCREW FE/ZNXC3	SECHSKANTSCHRAUBE FE/ZNXC3	VITE TESTA ESAGONALE FE/ZNXC3	
005	80061296	001	VIS TETE HEXAGONALE FE/ZNXC3	HEXAGON HEAD SCREW FE/ZNXC3	SECHSKANTSCHRAUBE FE/ZNXC3	VITE TESTA ESAGONALE FE/ZNXC3	
006	80201030	002	ECROU HEX.AUTOFREINE FE/ZNXC3	SELF-LOCKING NUT FE/ZNXC3	SELBSTSICH.MUTTER FE/ZNXC3	DADO AUTOBLOCCANTE FE/ZNXC3	
007	80201240	002	ECROU HEX.BAS AUTOFR.FE/ZNXC3	SELF-LOCKING NUT FE/ZNXC3	SELBSTSICHERND.MUTTER FE/ZNXC3	DADO AUTOBLOCCANTE FE/ZNXC3	
008	80204518	001	ECROU HK BAS FE/ZNXC3	HEXAGON CASTLE NUT FE/ZNXC3	FLACHE KRONENMUTTER FE/ZNXC3	DADO FE/ZNXC3	
009	80205566	002	ECROU A ENCOCH.AUTOF.FE/ZNXC3	SELF-LOCKING NUT FE/ZNXC3	SELBSTSICHERN.MUTTER FE/ZNXC3	DADO AUTOBLOCCANTE FE/ZNXC3	
010	80253556	004	RONDELLE PLATE FE/ZNXC3	PLAIN WASHER FE/ZNXC3	SCHEIBE FE/ZNXC3	RONDELLA PIATTA FE/ZNXC3	
011	80451061	002	GOUPILLE ELASTIQUE FLZNNC	ROLL PIN FLZNNC	SPANNHUELSE FLZNNC	SPINA ELASTICA FLZNNC	
012	80500780	001	GOUPILLE FENDUE FE/ZNXC3	SPLIT PIN FE/ZNXC3	SPLINT FE/ZNXC3	COPPIGLIA FE/ZNXC3	
013	80583500	006	CIRCLIP EXTERIEUR	RETAINING RING	SICHERUNGSRING	ANELLO	
014	82201016	009	GRAISSEUR AUTOTARAUDANT	SELF TAPPING GREASE NIPPLE	GEWINDESCHNEID-SCHMIERNIPPEL	INGRASSATORE	
015	83013539	004	BAGUE ROULEE	WRAPPED BUSH	GEROLLTE BUCHSE	ANELLO LUBRIFICATO	
016	H0100350	001	PLAQUETTE ARRETOIR	STOP PLATE	ARRETIERUNGSBLECH	PLACHETTA	
017	H0104010	001	AXE	PIN	ACHSE	ASSE	
018	H0204720	001	BOITIER	HOUSING	GEHAEUSE	SCATOLA	
019	H0204740	002	VERIN	CYLINDER, HYDRAULIC	HYDRAULIKZYLINDER	CILINDRO	
020	H0204780	001	CHAPE	CLEVIS	GABEL	FORCELLA	
021	H0204940	002	POIGNEE	HANDLE	HANDGRIFF	MANIGLIA	
022	H0204990	002	AXE	PIN	ACHSE	ASSE	
023	H0205000	006	AXE	PIN	ACHSE	ASSE	
024	H0205020	001	AXE	PIN	ACHSE	ASSE	
025	H0206040	001	PLAQUETTE	PLATE	PLATTE		
026	H0206480	001	AXE	PIN	ACHSE	ASSE	
027	H0206650	001	POCHETTE	KIT, SEAL	TACHE	SACCHE	: H0206640
028	H0206670	001	POCHETTE	KIT, SEAL	TACHE	SACCHE	: H0206660
029	H2207650	002	VIS	SCREW	SCHRAUBE	VITE	
030	H0204980	002	BIELLETTA	LINK	SCHUBSTANGE		

Замовлення за частини

(050)-407-68-47

(050)-407-68-45

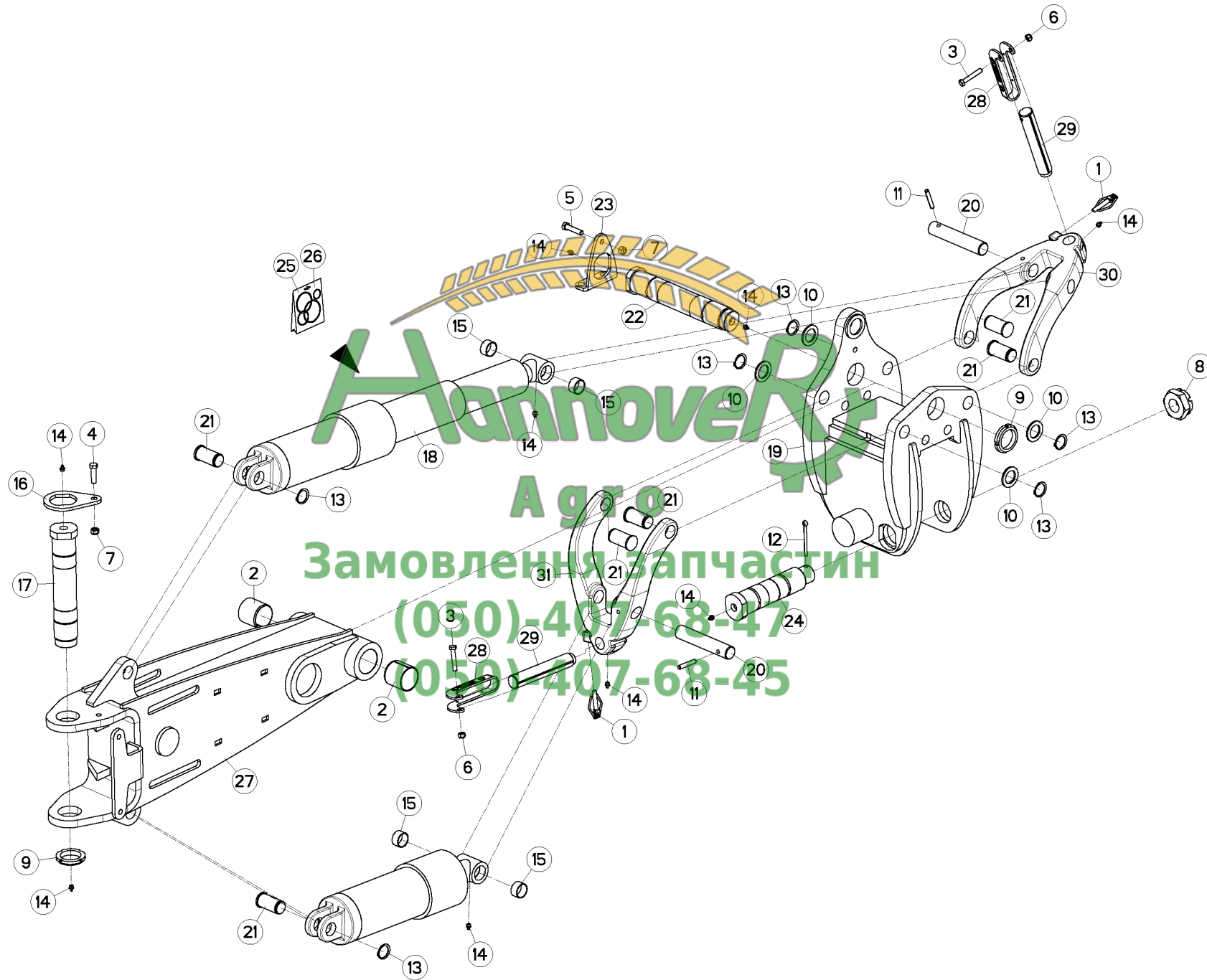



RETOURNEMENT

TURNOVER

DREHUNG

RIBALTAMENTO

Rep	Nr	Qt	Designation	Description	Bezeichnung	Referenza	Remarque - Remark - Bemerkung - Osservazioni
001	951408	002	GOUPILLE A RESSORT	LYNCH PIN	KLAPPSTECKER	COPPIGLIA DI SICUREZZA	
002	951521	002	BAGUE ELASTIQUE	TENSION BUSH	EINSPANNBUCHSE	SPINA ELASTICA	
003	80061054	002	VIS TETE HEXAGONALE FE/ZNXC3	HEXAGON HEAD SCREW FE/ZNXC3	SECHSKANTSCHRAUBE FE/ZNXC3	VITE TESTA ESAGONALE FE/ZNXC3	
004	80061245	001	VIS TETE HEXAGONALE FE/ZNXC3	HEXAGON HEAD SCREW FE/ZNXC3	SECHSKANTSCHRAUBE FE/ZNXC3	VITE TESTA ESAGONALE FE/ZNXC3	
005	80061296	001	VIS TETE HEXAGONALE FE/ZNXC3	HEXAGON HEAD SCREW FE/ZNXC3	SECHSKANTSCHRAUBE FE/ZNXC3	VITE TESTA ESAGONALE FE/ZNXC3	
006	80201030	002	ECROU HEX.AUTOFREINE FE/ZNXC3	SELF-LOCKING NUT FE/ZNXC3	SELBSTSICH.MUTTER FE/ZNXC3	DADO AUTOBLOCCANTE FE/ZNXC3	
007	80201240	002	ECROU HEX.BAS AUTOFR.FE/ZNXC3	SELF-LOCKING NUT FE/ZNXC3	SELBSTSICHERND.MUTTER FE/ZNXC3	DADO AUTOBLOCCANTE FE/ZNXC3	
008	80204518	001	ECROU HK BAS FE/ZNXC3	HEXAGON CASTLE NUT FE/ZNXC3	FLACHE KRONENMUTTER FE/ZNXC3	DADO FE/ZNXC3	
009	80205566	002	ECROU A ENCOCH.AUTOF.FE/ZNXC3	SELF-LOCKING NUT FE/ZNXC3	SELBSTSICHERN.MUTTER FE/ZNXC3	DADO AUTOBLOCCANTE FE/ZNXC3	
010	80253556	004	RONDELLE PLATE FE/ZNXC3	PLAIN WASHER FE/ZNXC3	SCHEIBE FE/ZNXC3	RONDELLA PIATTA FE/ZNXC3	
011	80451061	002	GOUPILLE ELASTIQUE FLZNNC	ROLL PIN FLZNNC	SPANNHUELSE FLZNNC	SPINA ELASTICA FLZNNC	
012	80500780	001	GOUPILLE FENDUE FE/ZNXC3	SPLIT PIN FE/ZNXC3	SPLINT FE/ZNXC3	COPPIGLIA FE/ZNXC3	
013	80583500	006	CIRCLIP EXTERIEUR	RETAINING RING	SICHERUNGSRING	ANELLO	
014	82201016	009	GRAISSEUR AUTOTARAUDANT	SELF TAPPING GREASE NIPPLE	GEWINDESCHNEID-SCHMIERNIPPEL	INGRASSATORE	
015	83013539	004	BAGUE ROULEE	WRAPPED BUSH	GEROLLTE BUCHSE	ANELLO LUBRIFICATO	
016	H0100350	001	PLAQUETTE ARRETOIR	STOP PLATE	ARRETIERUNGSBLECH	PLACHETTA	
017	H0104010	001	AXE	PIN	ACHSE	ASSE	
018	H0204740	001	VERIN	CYLINDER, HYDRAULIC	HYDRAULIKZYLINDER	CILINDRO	
019	H0204780	001	CHAPE	CLEVIS	GABEL	FORCELLA	
020	H0204990	002	AXE	PIN	ACHSE	ASSE	
021	H0205000	006	AXE	PIN	ACHSE	ASSE	
022	H0205020	001	AXE	PIN	ACHSE	ASSE	
023	H0206040	001	PLAQUETTE	PLATE	PLATTE		
024	H0206480	001	AXE	PIN	ACHSE	ASSE	
025	H0206650	001	POCHETTE	KIT, SEAL	TACHE	SACCHE	
026	H0206670	001	POCHETTE	KIT, SEAL	TACHE	SACCHE	
027	H0208730	001	BOITIER	HOUSING	GEHAEUSE	SCATOLA	
028	H0208800	002	POIGNEE	HANDLE	HANDGRIFF	MANIGLIA	
029	H2207650	002	VIS	SCREW	SCHRAUBE	VITE	
030	H0208830	001	BIELLETTA	LINK	SHUBSTANGE		
031	H0208840	001	BIELLETTA	LINK	SHUBSTANGE		

Замоклення зачастин

(050)-407-68-47

(050)-407-68-45

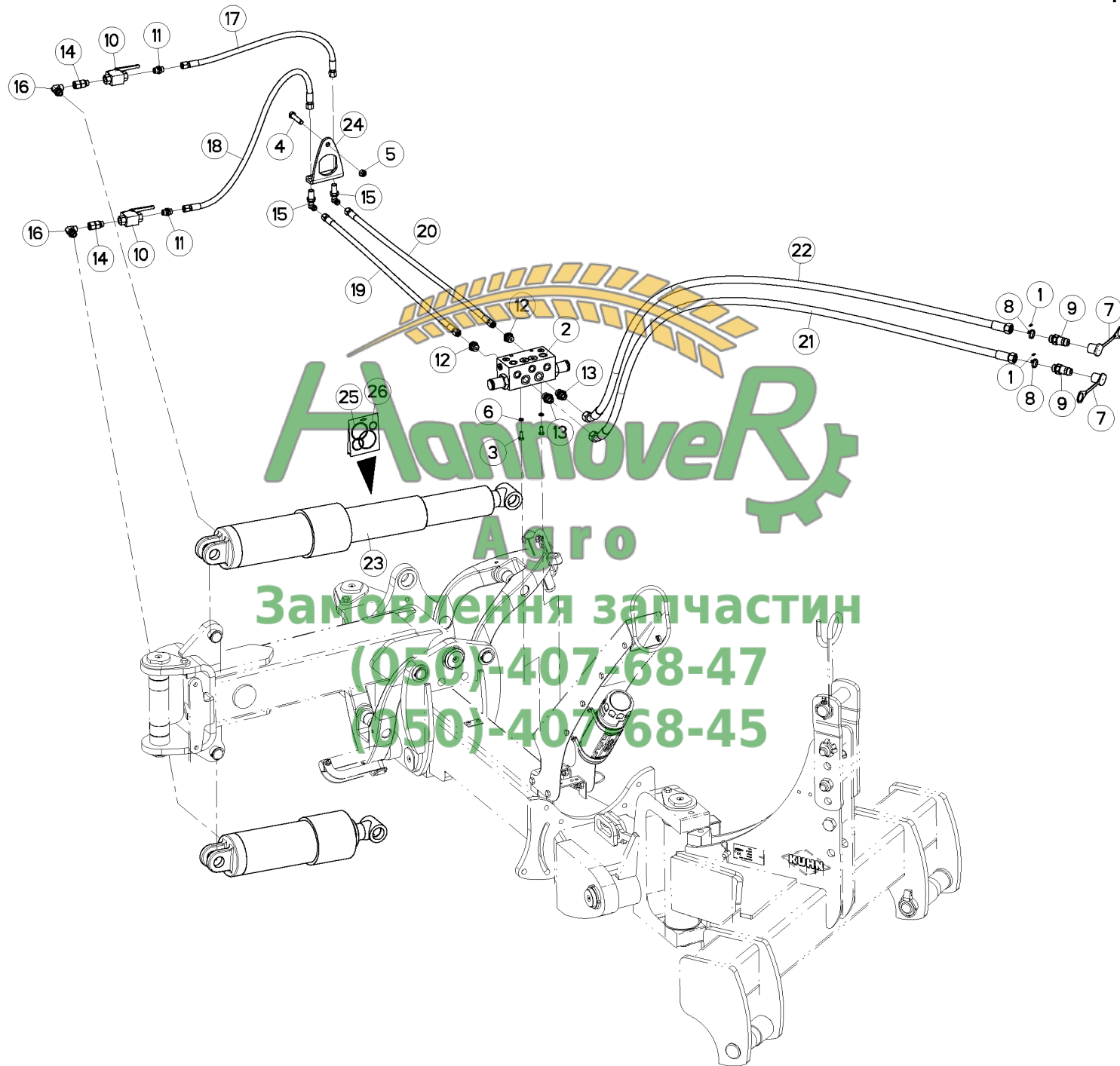



HYDRAULIQUE RETOURNEMENT

HYDRAULIC TURNOVER

HYDRAULIK DREHUNG

IDRAULICO RIBALTAMENTO

Rep	Nr	Qt	Designation	Description	Bezeichnung	Referenza	Remarque - Remark - Bemerkung - Osservazioni
001	951209	002	BAGUE	BUSHING	HUELSE	BOCCOLA	
002	951409	001	BLOC	BLOCK	BLOCK	BLOCCO	
003	80060820	002	VIS TETE HEXAGONALE FE/ZNXC3	HEXAGON HEAD SCREW FE/ZNXC3	SECHSKANTSCHRAUBE FE/ZNXC3	VITE TESTA ESAGONALE FE/ZNXC3	
004	80061296	001	VIS TETE HEXAGONALE FE/ZNXC3	HEXAGON HEAD SCREW FE/ZNXC3	SECHSKANTSCHRAUBE FE/ZNXC3	VITE TESTA ESAGONALE FE/ZNXC3	
005	80201240	002	ECROU HEX.BAS AUTOFR.FE/ZNXC3	SELF-LOCKING NUT FE/ZNXC3	SELBSTSICHERND.MUTTER FE/ZNXC3	DADO AUTOBLOCCANTE FE/ZNXC3	
006	80270803	002	RONDELLE GROWER FE/ZNXC3	SPRING LOCK WASHER FE/ZNXC3	FEDERRING FE/ZNXC3	RONDELLA GROWER FE/ZNXC3	
007	82300026	002	CAPUCHON COUPLEUR MALE	CAP MALE CONNECTOR	KAPPE KUPPLUNGSSTECKER	TAPPO	
008	83090093	002	COLLIER PLASTIQUE	CABLE TIE PLASTIC	KABELBINDER PLASTIK	FASCETTA	
009	A4074018	002	COUPLEUR MALE	CONNECTOR MALE	KUPPLUNGSTECKER	ATTACCO IDRAULICO	
010	A4075005	002	ROBINET	VALVE, BALL	KUGELHAHN	ROBINETTO	
011	A4080401	002	UNION MALE	MALE STUD CONNECTOR	GERADER EINSCHRAUBSTUTZEN	GIUZIONE DIRITTA ZBC	
012	A4080402	002	UNION MALE	MALE STUD CONNECTOR	GERADER EINSCHRAUBSTUTZEN	GIUZIONE DIRITTA ZBC	
013	A4080430	002	UNION MALE	MALE STUD CONNECTOR	GERADER EINSCHRAUBSTUTZEN	GIUZIONE DIRITTA ZBC	
014	A4080513	002	ADAPTATEUR MALE	SWIVEL CONNECTOR	EINSTELBARE EINSCHRAUBSTUTZE	ADATTATORE ZBC	
015	A4080750	002	COUDE EGAL/CLOISON FE/ZNXC3	BULKHEAD ELBOW FE/ZNXC3	WINKEL-SCHOTTVERSCHRAUBUNG	GOMITO ATTRAVERSAMENT.FE/ZNXC3	
016	A4082615	002	COUDE	FITTING, HYDRAULIC, ELBOW	BOGEN	CURVA	
017	A4921019	001	FLEXIBLE HYDRAULIQUE	HYDRAULIC HOSE	HYDRAULIKSCHLAUCH	TUBO GOMMA	<->760 mm
018	A4921019	001	FLEXIBLE HYDRAULIQUE	HYDRAULIC HOSE	HYDRAULIKSCHLAUCH	TUBO GOMMA	<->760 mm
019	A4921102	001	FLEXIBLE HYDRAULIQUE	HYDRAULIC HOSE	HYDRAULIKSCHLAUCH	TUBO GOMMA	<->850 mm
020	A4921102	001	FLEXIBLE HYDRAULIQUE	HYDRAULIC HOSE	HYDRAULIKSCHLAUCH	TUBO GOMMA	<->850 mm
021	A4923047	001	FLEXIBLE HYDRAULIQUE	HYDRAULIC HOSE	HYDRAULIKSCHLAUCH	TUBO GOMMA	<->2700 mm
022	A4923047	001	FLEXIBLE HYDRAULIQUE	HYDRAULIC HOSE	HYDRAULIKSCHLAUCH	TUBO GOMMA	<->2700 mm
023	H0204740	002	VERIN	CYLINDER, HYDRAULIC	HYDRAULIKZYLINDER	CILINDRO	
024	H0206040	001	PLAQUETTE	PLATE	PLATTE		
025	H0206650	001	POCHETTE	KIT, SEAL	TACHE	SACCHE	: H0206640
026	H0206670	001	POCHETTE	KIT, SEAL	TACHE	SACCHE	: H0206660

(050)-407-68-47
 (050)-407-68-45

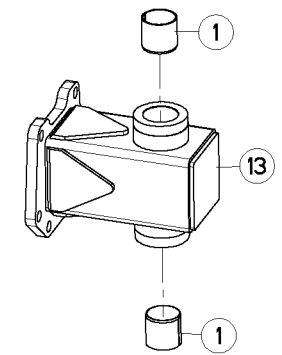



TIMON MLD

DRAWBAR MLD

DEICHSEL MLD

TIMONE MLD

Rep	Nr	Qt	Designation	Description	Bezeichnung	Referenza	Remarque - Remark - Bemerkung - Osservazioni
001	951521	002	BAGUE ELASTIQUE	TENSION BUSH	EINSPANNBUECHSE	SPINA ELASTICA	
002	80061245	001	VIS TETE HEXAGONALE FE/ZNXC3	HEXAGON HEAD SCREW FE/ZNXC3	SECHSKANTSCHRAUBE FE/ZNXC3	VITE TESTA ESAGONALE FE/ZNXC3	
003	80062068	006	VIS TETE HEXAGONALE FLZNNC	HEXAGON HEAD SCREW FLZNNC	SECHSKANTSCHRAUBE FLZNNC	VITE TESTA ESAGONALE FLZNNC	
004	80201240	001	ECROU HEX.BAS AUTOFR.FE/ZNXC3	SELF-LOCKING NUT FE/ZNXC3	SELBSTSICHERND.MUTTER FE/ZNXC3	DADO AUTOBLOCCANTE FE/ZNXC3	
005	80202047	006	ECROU HEXAG.AUTOFREINE FLZNNC	SELF-LOCKING NUT FLZNNC	SELBSTSICHERNDE.MUTTER FLZNNC	DADO AUTOBLOCCANTE FLZNNC	
006	80202069	006	ECROU HEXAGONAL FE/ZNXC3	NUT FE/ZNXC3	SECHSKANTMUTTER FE/ZNXC3	DADO FE/ZNXC3	
007	80205566	001	ECROU A ENCOCH.AUTOF.FE/ZNXC3	SELF-LOCKING NUT FE/ZNXC3	SELBSTSICHERN.MUTTER FE/ZNXC3	DADO AUTOBLOCCANTE FE/ZNXC3	
008	82201016	002	GRAISSEUR AUTOTARAUDANT	SELF TAPPING GREASE NIPPLE	GEWINDESCHNEID-SCHMIERNIPPEL	INGRASSATORE	
009	H0100350	001	PLAQUETTE ARRETOIR	STOP PLATE	ARRETIERUNGSBLECH	PLACHETTA	
010	H0104010	001	AXE	PIN	ACHSE	ASSE	
011	H0204840	001	FOURREAU	SHEATH, RIGID	KULISSE		
012	H0204910	001	GLISSIERE	GUIDE, SLIDE	GLEITSCHIENE	SLITTA	
013	H0204920	001	PIVOT	PIVOT	GELENKBOLZEN	PERNO	



Замовлення запчастин

(050)-407-68-47

(050)-407-68-45

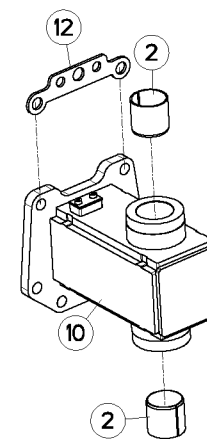



TIMON VLD

DRAWBAR VLD

DEICHSEL VLD

TIMONE VLD

Rep	Nr	Qt	Designation	Description	Bezeichnung	Referenza	Remarque - Remark - Bemerkung - Osservazioni
001	H0104010	001	AXE	PIN	ACHSE	ASSE	
002	951521	002	BAGUE ELASTIQUE	TENSION BUSH	EINSPANNBUCHSE	SPINA ELASTICA	
003	80205566	001	ECROU A ENCOCH.AUTOF.FE/ZNXC3	SELF-LOCKING NUT FE/ZNXC3	SELBSTSICHERN.MUTTER FE/ZNXC3	DADO AUTOBLOCCANTE FE/ZNXC3	
004	80201240	001	ECROU HEX.BAS AUTOFR.FE/ZNXC3	SELF-LOCKING NUT FE/ZNXC3	SELBSTSICHERND.MUTTER FE/ZNXC3	DADO AUTOBLOCCANTE FE/ZNXC3	
005	80202047	006	ECROU HEXAG.AUTOFREINE FLZNNC	SELF-LOCKING NUT FLZNNC	SELBSTSICHERNDE.MUTTER FLZNNC	DADO AUTOBLOCCANTE FLZNNC	
006	80202069	006	ECROU HEXAGONAL FE/ZNXC3	NUT FE/ZNXC3	SECHSKANTMUTTER FE/ZNXC3	DADO FE/ZNXC3	
007	H0204840	001	FOURREAU	SHEATH, RIGID	KULISSE		
008	H0204910	001	GLISSIERE	GUIDE, SLIDE	GLEITSCHIENE	SLITTA	
009	82201016	002	GRAISSEUR AUTOTARAUDANT	SELF TAPPING GREASE NIPPLE	GEWINDESCHNEID-SCHMIERNIPPEL	INGRASSATORE	
010	H0204921	001	PIVOT	PIVOT	GELENKBOLZEN	PERNO	
011	H0100350	001	PLAQUETTE ARRETOIR	STOP PLATE	ARRETIERUNGSBLECH	PLACHETTA	
012	H0208810	001	SUPPORT	SUPPORT	TRAEGER	SUPPORTO	
013	80061245	001	VIS TETE HEXAGONALE FE/ZNXC3	HEXAGON HEAD SCREW FE/ZNXC3	SECHSKANTSCHRAUBE FE/ZNXC3	VITE TESTA ESAGONALE FE/ZNXC3	
014	80062067	002	VIS TETE HEXAGONALE FLZNNC	HEXAGON HEAD SCREW FLZNNC	SECHSKANTSCHRAUBE FLZNNC	VITE TESTA ESAGONALE FLZNNC	
015	80062068	004	VIS TETE HEXAGONALE FLZNNC	HEXAGON HEAD SCREW FLZNNC	SECHSKANTSCHRAUBE FLZNNC	VITE TESTA ESAGONALE FLZNNC	

Агро

Замовлення запчастин

(050)-407-68-47

(050)-407-68-45



Замовлення запчастин
(050)-407-68-47
(050)-407-68-45



MLD7ET
MLD8T

C0000 >
C0000 >

H02R0203 B

EXTENSION (TIMON)

EXTENSION (DRAWBAR)

ERWEITERUNG (DEICHSEL)

PROLUNGA (TIMONE)

Rep	Nr	Qt	Designation	Description	Bezeichnung	Referenza	Remarque - Remark - Bemerkung - Osservazioni
001	80060612	004	VIS TETE HEXAGONALE FE/ZNXC3	HEXAGON HEAD SCREW FE/ZNXC3	SECHSKANTSCHRAUBE FE/ZNXC3	VITE TESTA ESAGONALE FE/ZNXC3	
002	80060635	004	VIS TETE HEXAGONALE FE/ZNXC3	HEXAGON HEAD SCREW FE/ZNXC3	SECHSKANTSCHRAUBE FE/ZNXC3	VITE TESTA ESAGONALE FE/ZNXC3	
003	80062068	006	VIS TETE HEXAGONALE FLZNNC	HEXAGON HEAD SCREW FLZNNC	SECHSKANTSCHRAUBE FLZNNC	VITE TESTA ESAGONALE FLZNNC	
004	80202047	006	ECROU HEXAG.AUTOFREINE FLZNNC	SELF-LOCKING NUT FLZNNC	SELBSTSICHERNDE MUTTER FLZNNC	DADO AUTOBLOCCANTE FLZNNC	
005	80202069	006	ECROU HEXAGONAL FE/ZNXC3	NUT FE/ZNXC3	SECHSKANTMUTTER FE/ZNXC3	DADO FE/ZNXC3	
006	80250611	004	RONDELLE PLATE FE/ZNXC3	PLAIN WASHER FE/ZNXC3	SCHEIBE FE/ZNXC3	RONDELLA PIATTA FE/ZNXC3	
007	A7260029	002	COLLIER SIMPLE D22 NU	CLAMP D.22	SHELLE D.22	COLLARE D.22	
008	H0204830	001	EXTENSION	EXTENSION	ERWEITERUNG	EXTENSIONE	
009	H0206620	001	TOLE DE PROTECTION	SHIELD, RIGID	SCHUTZBLECH	LAMIERA DI PROTEZIONE	
010	H0206630	002	PONTET	BRIDGE	ABZUGSBUGEL		



Замовлення запчастин

(050)-407-68-47

(050)-407-68-45





DEPORT MÉCANIQUE

MECHANICAL OFFSET

MECH. VORDERFURCHENEINSTELLUNG SFALSAMENTO MECCANICO

Rep	Nr	Qt	Designation	Description	Bezeichnung	Referenza	Remarque - Remark - Bemerkung - Osservazioni
001	80061271	002	VIS TETE HEXAGONALE FE/ZNXC3	HEXAGON HEAD SCREW FE/ZNXC3	SECHSKANTSCHRAUBE FE/ZNXC3	VITE TESTA ESAGONALE FE/ZNXC3	
002	80203003	001	ECROU HEXAGONAL BAS FE/ZNXC3	NUT FE/ZNXC3	SECHSKANTMUTTER FE/ZNXC3	DADO FE/ZNXC3	
003	80271203	002	RONDELLE GROWER FE/ZNXC3	SPRING LOCK WASHER FE/ZNXC3	FEDERING FE/ZNXC3	RONDELLA GROWER FE/ZNXC3	
004	82201016	002	GRAISSEUR AUTOTARAUDANT	SELF TAPPING GREASE NIPPLE	GEWINDESCHNEID-SCHMIERNIPPEL	INGRASSATORE	
005	H0205970	001	TIRANT	TIE ROD	ZUGSTANGE	TIRANTE	
006	H0205980	002	AXE	PIN	ACHSE	ASSE	
007	H0205990	004	ENTRETOISE	SPACER	DISTANZHUELSE	DISTANZIALE	



Замовлення запчастин

(050)-407-68-47

(050)-407-68-45



Замовлення запчастин
(050)-407-68-47
(050)-407-68-45



DEPORT HYDRAULIQUE

HYDRAULIC OFFSET

HYDR. VORDERFURCHEINSTELLUNG

SFALSAMENTO IDRAULICO

Rep	Nr	Qt	Designation	Description	Bezeichnung	Referenza	Remarque - Remark - Bemerkung - Osservazioni
001	951211	002	BAGUE	BUSHING	HUELSE	BOCCOLA	
002	951409	001	BLOC	BLOCK	BLOCK	BLOCCO	
003	80060635	014	VIS TETE HEXAGONALE FE/ZNXC3	HEXAGON HEAD SCREW FE/ZNXC3	SECHSKANTSCHRAUBE FE/ZNXC3	VITE TESTA ESAGONALE FE/ZNXC3	
004	80061225	001	VIS TETE HEXAGONALE FE/ZNXC3	HEXAGON HEAD SCREW FE/ZNXC3	SECHSKANTSCHRAUBE FE/ZNXC3	VITE TESTA ESAGONALE FE/ZNXC3	
005	80061271	002	VIS TETE HEXAGONALE FE/ZNXC3	HEXAGON HEAD SCREW FE/ZNXC3	SECHSKANTSCHRAUBE FE/ZNXC3	VITE TESTA ESAGONALE FE/ZNXC3	
006	82300026	002	CAPUCHON COUPLEUR MALE	CAP MALE CONNECTOR	KAPPE KUPPLUNGSTECKER	TAPPO	
007	80271203	003	RONDELLE GROWER FE/ZNXC3	SPRING LOCK WASHER FE/ZNXC3	FEDERRING FE/ZNXC3	RONDELLA GROWER FE/ZNXC3	
008	83090093	002	COLLIER PLASTIQUE	CABLE TIE PLASTIC	KABELBINDER PLASTIK	FASCETTA	
009	A4074017	002	COUPLEUR MALE	CONNECTOR MALE	KUPPLUNGSTECKER	INNESTO M16X150	
010	A4080300	008	UNION DOUBLE FE/ZNXC3	STRAIGHT COUPLING FE/ZNXC3	GERADE VERSCHRAUBUNG FE/ZNXC3	GIUNZIONE DIRITTA FE/ZNXC3	
011	A4080401	006	UNION MALE	MALE STUD CONNECTOR	GERADER EINSCHRAUBSTUTZEN	GIUZIONE DIRITTA ZBC	
012	A4080750	002	COUDE EGAL/CLOISON FE/ZNXC3	BULKHEAD ELBOW FE/ZNXC3	WINKEL-SCHOTTVERSCHRAUBUNG	GOMITO ATTRAVERSAMENT.FE/ZNXC3	
013	A4921014	002	FLEXIBLE HYDRAULIQUE	HYDRAULIC HOSE	HYDRAULIKSCHLAUCH	TUBO GOMMA	<->300 mm
014	A7260029	001	COLLIER SIMPLE D22 NU	CLAMP D.22	SCHELLE D.22	COLLARE D.22	
015	A4921023	001	FLEXIBLE HYDRAULIQUE	HYDRAULIC HOSE	HYDRAULIKSCHLAUCH	TUBO GOMMA	<->995 mm
016	A4921023	001	FLEXIBLE HYDRAULIQUE	HYDRAULIC HOSE	HYDRAULIKSCHLAUCH	TUBO GOMMA	<->995 mm
017	A4921023	001	FLEXIBLE HYDRAULIQUE	HYDRAULIC HOSE	HYDRAULIKSCHLAUCH	TUBO GOMMA	<->995 mm
018	A4921023	001	FLEXIBLE HYDRAULIQUE	HYDRAULIC HOSE	HYDRAULIKSCHLAUCH	TUBO GOMMA	<->995 mm
019	A4921042	001	FLEXIBLE HYDRAULIQUE	HYDRAULIC HOSE	HYDRAULIKSCHLAUCH	TUBO GOMMA	<->2730 mm
020	A4921042	001	FLEXIBLE HYDRAULIQUE	HYDRAULIC HOSE	HYDRAULIKSCHLAUCH	TUBO GOMMA	<->2730 mm
021	A4921069	001	FLEXIBLE	HOSE, HYDRAULIC	HYDRAULIKSCHLAUCH	TUBO IN GOMMA	<->810 mm
022	A4921069	001	FLEXIBLE	HOSE, HYDRAULIC	HYDRAULIKSCHLAUCH	TUBO IN GOMMA	<->810 mm
023	A4921098	001	FLEXIBLE HYDRAULIQUE	HYDRAULIC HOSE	HYDRAULIKSCHLAUCH	TUBO GOMMA	<->400 mm
024	A4921098	001	FLEXIBLE HYDRAULIQUE	HYDRAULIC HOSE	HYDRAULIKSCHLAUCH	TUBO GOMMA	<->400 mm
025	A4921101	001	FLEXIBLE HYDRAULIQUE	HYDRAULIC HOSE	HYDRAULIKSCHLAUCH	TUBO GOMMA	<->800 mm
026	A4921101	001	FLEXIBLE HYDRAULIQUE	HYDRAULIC HOSE	HYDRAULIKSCHLAUCH	TUBO GOMMA	<->800 mm
027	H0205770	001	CARTER	HOUSING	GEHAEUSE	SCATOLA	
028	H0205780	002	AXE	PIN	ACHSE	ASSE	
029	H0205960	001	VERIN	CYLINDER, HYDRAULIC	HYDRAULIKZYLINDER	CILINDRO	
030	H0206080	007	PONTET	BRIDGE	ABZUGSBUGEL		
031	H0208810	001	SUPPORT	SUPPORT	TRAEGER	SUPPORTO	
032	K3606570	002	ENTRETOISE	SPACER	DISTANZHUELSE	DISTANZIALE	

Адрес: (050)-407-68-47
 (050)-407-68-45





INDICATEUR DE POSITION (DEPORT

POSITION INDICATOR (OFF SETTIN

STELLUNGSANZEIGE (VERSATZSTUEC

INDICATORE DI POSIZIONE (SFALS

Rep	Nr	Qt	Designation	Description	Bezeichnung	Referenza	Remarque - Remark - Bemerkung - Osservazioni
001	80061241	004	VIS TETE HEXAGONALE FE/ZNXC3	HEXAGON HEAD SCREW FE/ZNXC3	SECHSKANTSCHRAUBE FE/ZNXC3	VITE TESTA ESAGONALE FE/ZNXC3	
002	80061245	002	VIS TETE HEXAGONALE FE/ZNXC3	HEXAGON HEAD SCREW FE/ZNXC3	SECHSKANTSCHRAUBE FE/ZNXC3	VITE TESTA ESAGONALE FE/ZNXC3	
003	80201240	006	ECROU HEX.BAS AUTOFR.FE/ZNXC3	SELF-LOCKING NUT FE/ZNXC3	SELBSTSICHERND.MUTTER FE/ZNXC3	DADO AUTOBLOCCANTE FE/ZNXC3	
004	80251227	002	RONDELLE PLATE FE/ZNXC3	PLAIN WASHER FE/ZNXC3	SCHEIBE FE/ZNXC3	RONDELLA PIATTA FE/ZNXC3	
005	80451061	001	GOUPILLE ELASTIQUE FLZNNC	ROLL PIN FLZNNC	SPANNHUELSE FLZNNC	SPINA ELASTICA FLZNNC	
006	80581200	002	CIRCLIP EXTERIEUR	RETAINING RING	SICHERUNGSRING	ANELLO	
007	950219	001	AUTOCOL. INDEXAGE HYD	STICKER "HYDRAULIC INDEX"	AUFKLEBER	ADESIVO	
008	H0206390	001	SUPPORT	SUPPORT	TRAEGER	SUPPORTO	
009	H0206400	001	REGLETTE	GAUGE, GRADUATED	ANZEIGE	BARRETTA	
010	H0206410	001	REGLETTE	GAUGE, GRADUATED	ANZEIGE	BARRETTA	
011	H0206440	001	INDICATEUR	INDICATOR	ANZEIGER	INDICATORE	
012	H0207030	001	BIELLETTE	LINK	SHUBSTANGE		
013	H0207040	001	BIELLETTE	LINK	SHUBSTANGE		



Замовлення запчастин

(050)-407-68-47

(050)-407-68-45





INDICATEUR DE POSITION DEPORT

POSITION INDICATOR OFF SETTING

STELLUNGSANZEIGE VERSATZSTUECK

INDICATORE DI POSIZIONE SFALSA

Rep	Nr	Qt	Designation	Description	Bezeichnung	Referenza	Remarque - Remark - Bemerkung - Osservazioni
001	80061241	004	VIS TETE HEXAGONALE FE/ZNXC3	HEXAGON HEAD SCREW FE/ZNXC3	SECHSKANTSCHRAUBE FE/ZNXC3	VITE TESTA ESAGONALE FE/ZNXC3	
002	80061245	002	VIS TETE HEXAGONALE FE/ZNXC3	HEXAGON HEAD SCREW FE/ZNXC3	SECHSKANTSCHRAUBE FE/ZNXC3	VITE TESTA ESAGONALE FE/ZNXC3	
003	80201240	006	ECROU HEX.BAS AUTOFR.FE/ZNXC3	SELF-LOCKING NUT FE/ZNXC3	SELBSTSICHERND.MUTTER FE/ZNXC3	DADO AUTOBLOCCANTE FE/ZNXC3	
004	80251227	004	RONDELLE PLATE FE/ZNXC3	PLAIN WASHER FE/ZNXC3	SCHEIBE FE/ZNXC3	RONDELLA PIATTA FE/ZNXC3	
005	80451061	001	GOUPILLE ELASTIQUE FLZNNC	ROLL PIN FLZNNC	SPANNHUELSE FLZNNC	SPINA ELASTICA FLZNNC	
006	950219	001	AUTOCOL. INDEXAGE HYD	STICKER "HYDRAULIC INDEX"	AUFKLEBER	ADESIVO	
007	H0206390	001	SUPPORT	SUPPORT	TRAEGER	SUPPORTO	
008	H0206400	001	REGLETTE	GAUGE, GRADUATED	ANZEIGE	BARRETTA	
009	H0206410	001	REGLETTE	GAUGE, GRADUATED	ANZEIGE	BARRETTA	
010	H0206440	001	INDICATEUR	INDICATOR	ANZEIGER	INDICATORE	
011	H0207030	001	BIELLETTTE	LINK	SHUBSTANGE		
012	H0207040	001	BIELLETTTE	LINK	SHUBSTANGE		



Замовлення запчастин

(050)-407-68-47

(050)-407-68-45



Hannover
Агро

Замовлення запчастин
(050)-407-68-47
(050)-407-68-45



STRUCTURE MLD

STRUCTURE MLD

STRUKTURTEILE MLD

STRUTTURA MLD

Rep	Nr	Qt	Designation	Description	Bezeichnung	Referenza	Remarque - Remark - Bemerkung - Osservazioni
001	421223	002	RONDELLE	WASHER	SCHEIBE	RONDELLA PIATTA	
002	493115	001	ROULEMT.RLX CON 100X150X39	BEARING, ROLLER	ROLLENLAGER	CUSCINETTO	
003	900769	001	ANNEAU D'ETANCHEITE 33020	SEALING RING 33020	ANSCHLAGRING 33020	ANELLO	
004	951521	002	BAGUE ELASTIQUE	TENSION BUSH	EINSPANNBUECHSE	SPINA ELASTICA	
005	80062049	004	VIS TETE HEXAGONALE FE/ZNXC3	HEXAGON HEAD SCREW FE/ZNXC3	SECHSKANTSCHRAUBE FE/ZNXC3	VITE TESTA ESAGONALE FE/ZNXC3	
006	80062067	009	VIS TETE HEXAGONALE FLZNNC	HEXAGON HEAD SCREW FLZNNC	SECHSKANTSCHRAUBE FLZNNC	VITE TESTA ESAGONALE FLZNNC	
007	80062084	001	VIS TETE HEXAGONALE FLZNNC	HEXAGON HEAD SCREW FLZNNC	SECHSKANTSCHRAUBE FLZNNC	VITE TESTA ESAGONALE FLZNNC	
008	80062484	002	VIS TETE HEXAGONALE FLZNNC	HEXAGON HEAD SCREW FLZNNC	SECHSKANTSCHRAUBE FLZNNC	VITE TESTA ESAGONALE FLZNNC	
009	80202047	010	ECROU HEXAG.AUTOFREINE FLZNNC	SELF-LOCKING NUT FLZNNC	SELBSTSICHERNDE MUTTER FLZNNC	DADO AUTOBLOCCANTE FLZNNC	
010	80202069	014	ECROU HEXAGONAL FE/ZNXC3	NUT FE/ZNXC3	SECHSKANTMUTTER FE/ZNXC3	DADO FE/ZNXC3	
011	80202442	002	ECROU HEX.BAS AUTOFR.FE/ZNXC3	SELF-LOCKING NUT FE/ZNXC3	SELBSTSICHERND.MUTTER FE/ZNXC3	DADO AUTOBLOCCANTE FE/ZNXC3	
012	80204566	001	ECROU A ENCOCH.AUTOF.FE/ZNXC3	SELF-LOCKING NUT FE/ZNXC3	SELBSTSICHERN.MUTTER FE/ZNXC3	DADO AUTOBLOCCANTE FE/ZNXC3	
013	80208018	001	ECROU A ENCOCHES	SLOTTED ROUND NUT	NUTMUTTER	DADO	40 daN.m (295 lbf.ft)
014	80298020	001	RONDELLE-FREIN	WASHER, TAB LOCK	SICHERUNGSBLECH	RONDELLA-FRENO	
015	81309613	001	ROULEMENT A ROULEAUX CONIQUES	TAPERED ROLLER BEARING	KEGELROLLENLAGER	CUSCINETTO A RULLI	
016	82158501	001	ANNEAU NILOS	FLEXIBLE AXIAL SEAL WASHER	FEDERENDE AXIALDICHTSCHEIBE	ANELLO	
017	82201016	001	GRAISSEUR AUTOTARAUDANT	SELF TAPPING GREASE NIPPLE	GEWINDESCHNEID-SCHMIERNIPPEL	INGRASSATORE	
018	H0202840	001	DENT	TINE	ZINKEN	DENTE	
019	H0204850	001	BARRE	BAR	BALKEN	BARRA	
020	H0204870	001	BATI	FRAME, MAIN	RAHMEN	TELAIO	
021	H0204880	001	FIXATION	MOUNT	VERBINDUNGSSTUECK	ATTACCO GANCIO	
022	H0204901	001	BRAS	ARM	ARM	BRACCIO	
023	H0204960	001	AXE	PIN	ACHSE	ASSE	
024	H0204970	001	FIXATION	MOUNT	VERBINDUNGSSTUECK	ATTACCO GANCIO	: BOT / ON-LAND
025	H0602760	001	SUPPORT	SUPPORT	TRAEGER	SUPPORTO	

Замовлення запчастин

(050)-407-68-47

(050)-407-68-45





MLD7ET
MLD8T

C0000 >
C0000 >

H02R0199 A

EXTENSION MEDIANE

MIDDLE EXTENSION

MITTEL ERWEITERUNG

ESTENSIONE CENTRALE

Rep	Nr	Qt	Designation	Description	Bezeichnung	Referenza	Remarque - Remark - Bemerkung - Osservazioni
001	80062067	010	VIS TETE HEXAGONALE FLZNNC	HEXAGON HEAD SCREW FLZNNC	SECHSKANTSCHRAUBE FLZNNC	VITE TESTA ESAGONALE FLZNNC	
002	80202047	010	ECROU HEXAG.AUTOFREINE FLZNNC	SELF-LOCKING NUT FLZNNC	SELBSTSICHERNDE MUTTER FLZNNC	DADO AUTOBLOCCANTE FLZNNC	
003	80202069	010	ECROU HEXAGONAL FE/ZNXC3	NUT FE/ZNXC3	SECHSKANTMUTTER FE/ZNXC3	DADO FE/ZNXC3	
004	H0204890	001	EXTENSION	EXTENSION	ERWEITERUNG	EXTENSIONE	



Замовлення запчастин

(050)-407-68-47

(050)-407-68-45

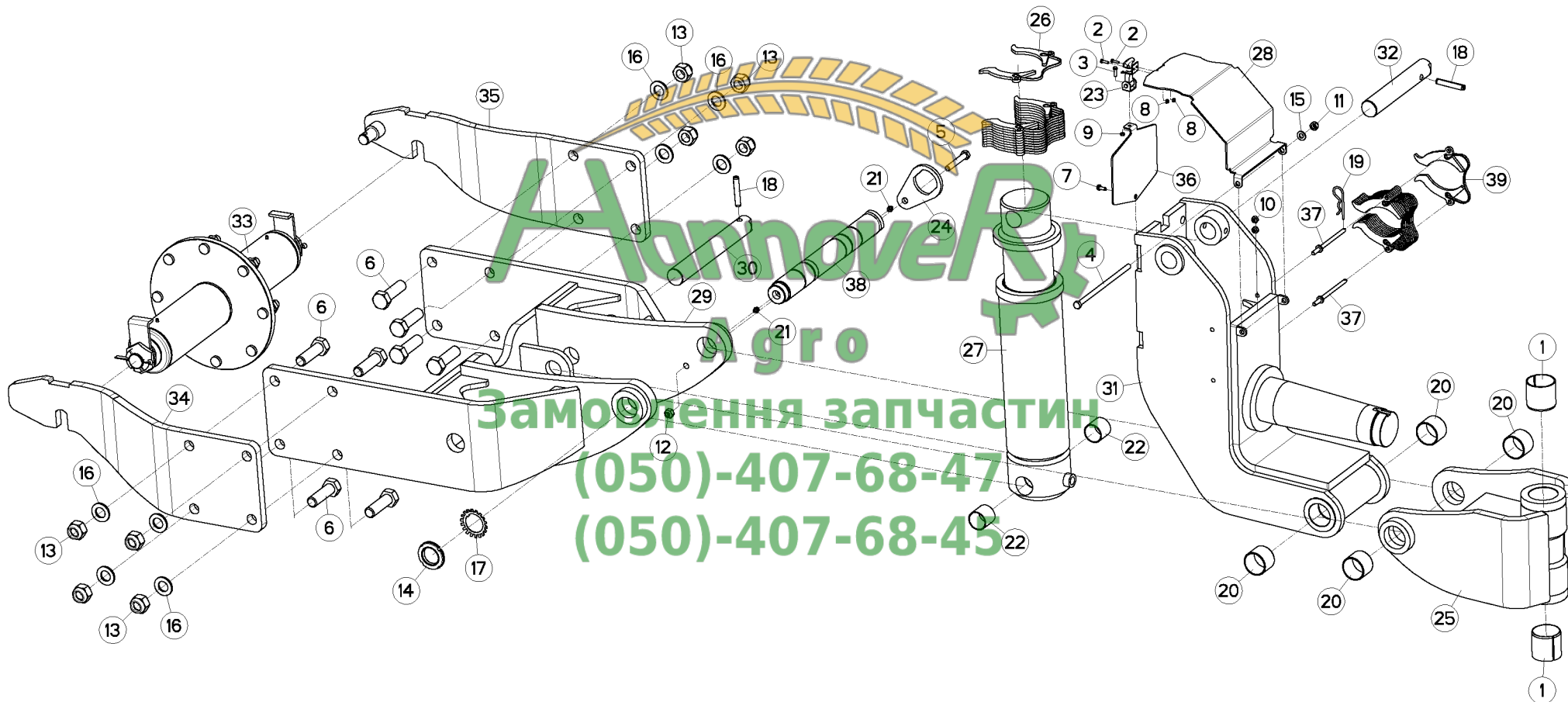



SUPPORT DE ROUE MLD

WHEEL SUPPORT MLD

RADHALTERUNG MLD

SUPPORTO RUOTA MLD

Rep	Nr	Qt	Designation	Description	Bezeichnung	Referenza	Remarque - Remark - Bemerkung - Osservazioni
001	951521	002	BAGUE ELASTIQUE	TENSION BUSH	EINSPANNBUECHSE	SPINA ELASTICA	
002	80060416	002	VIS TETE HEXAGONALE FE/ZNXC3	HEXAGON HEAD SCREW FE/ZNXC3	SECHSKANTSCHRAUBE FE/ZNXC3	VITE TESTA ESAGONALE FE/ZNXC3	
003	80060518	001	VIS TETE HEXAGONALE FE/ZNXC3	HEXAGON HEAD SCREW FE/ZNXC3	SECHSKANTSCHRAUBE FE/ZNXC3	VITE TESTA ESAGONALE FE/ZNXC3	
004	80061090	001	VIS TETE HEXAGONALE FE/ZNXC3	HEXAGON HEAD SCREW FE/ZNXC3	SECHSKANTSCHRAUBE FE/ZNXC3	VITE TESTA ESAGONALE FE/ZNXC3	
005	80061255	001	VIS TETE HEXAGONALE	HEXAGON HEAD SCREW	SECHSKANTSCHRAUBE	VITE A TESTA ESAGONALE	
006	80062480	008	VIS TETE HEXAGONALE FE/ZNXC3	HEXAGON HEAD SCREW FE/ZNXC3	SECHSKANTSCHRAUBE FE/ZNXC3	VITE TESTA ESAGONALE FE/ZNXC3	
007	80190616	001	VIS A TOLE TETE H FE/ZNXC3	HEXAGON HEAD TAPPING SCREWS	SECHSKANT-BLECHSCHRAUBEN		
008	80200440	002	ECROU HEX.AUTOFREINE FE/ZNXC3	SELF-LOCKING NUT FE/ZNXC3	SELBSTSICHERNDE MUTT.FE/ZNXC3	DADO AUTOBLOCCANTE FE/ZNXC3	
009	80200540	001	ECROU HEX.BAS AUTOFR.FE/ZNXC3	SELF-LOCKING NUT FE/ZNXC3	SELBSTSICHERND.MUTTER FE/ZNXC3	DADO AUTOBLOCCANTE FE/ZNXC3	
010	80200840	002	ECROU HEX.BAS AUTOFR.FE/ZNXC3	SELF-LOCKING NUT FE/ZNXC3	SELBSTSICHERND.MUTTER FE/ZNXC3	DADO AUTOBLOCCANTE FE/ZNXC3	
011	80201030	001	ECROU HEX.AUTOFREINE FE/ZNXC3	SELF-LOCKING NUT FE/ZNXC3	SELBSTSICH.MUTTER FE/ZNXC3	DADO AUTOBLOCCANTE FE/ZNXC3	
012	80201240	001	ECROU HEX.BAS AUTOFR.FE/ZNXC3	SELF-LOCKING NUT FE/ZNXC3	SELBSTSICHERND.MUTTER FE/ZNXC3	DADO AUTOBLOCCANTE FE/ZNXC3	
013	80202447	008	ECROU HEXA.AUTOFREINE FE/ZNXC3	SELF-LOCKING NUT FE/ZNXC3	SELBSTSICHERNDE MUTT.FE/ZNXC3	DADO AUTOBLOCCANTE FE/ZNXC3	
014	80204517	001	ECROU A ENCOCHES	SLOTTED ROUND NUT	NUTMUTTER	DADO	
015	80251021	001	RONDELLE PLATE FE/ZNXC3	PLAIN WASHER FE/ZNXC3	SCHEIBE FE/ZNXC3	RONDELLA PIATTA FE/ZNXC3	
016	80252432	008	RONDELLE PLATE FE/ZNXC3	PLAIN WASHER FE/ZNXC3	SCHEIBE FE/ZNXC3	RONDELLA PIATTA FE/ZNXC3	
017	80294519	001	RONDELLE-FREIN	TAB WASHER	SICHERUNGSBLECH	RONDELLA-FRENO	
018	80441270	002	GOUPILLE SPIRALE	ROLL PIN	SPIRAL SPANNSTIFTE	SPINA ELASTICA	
019	80570477	001	GOUPILLE BETA SIMPLE FE/ZNXC3	SPRING COTTER PIN FE/ZNXC3	FEDERSTECKER FE/ZNXC3	MOLLA FE/ZNXC3	
020	80471000	004	BAGUE ELASTIQUE	TENSION BUSH	EINSPANNBUECHSE	SPINA ELASTICA	
021	82201016	002	GRAISSEUR AUTOTARAUDANT	SELF TAPPING GREASE NIPPLE	GEWINDESCHNEID-SCHMIERNIPPEL	INGRASSATORE	
022	83014043	002	BAGUE ROULEE	WRAPPED BUSH	GEROLLTE BUCHSE	ANELLO LUBRIFICATO	
023	A7200102	001	ATTACHE	SUPPORT	HALTERUNG	ATTACCO	
024	H0104240	001	PLAQUETTE	PLATE	PLATTE	PLACHETTA	
025	H0206970	001	CARDAN	JOINT, UNIVERSAL	KREUZGELENK	CARDANO	
026	H0505030	010	CALE	SHIM	DISTANZPLATTE	SPESSORE	
027	H0505130	001	VERIN	CYLINDER, HYDRAULIC	HYDRAULIKZYLINDER	CILINDRO	
028	H0505180	001	COUVERCLE	LID	DECKEL	COPERCHIO	
029	H0507110	001	FOURCHE	TINE, MULTIPLE	ZINKEN	FORCA	
030	H0507130	001	AXE	PIN	ACHSE	ASSE	
031	H0507140	001	SUPPORT	SUPPORT	TRAEGER	SUPPORTO	
032	H0507150	001	AXE	PIN	ACHSE	ASSE	
033	H0507250	001	MOYEU	HUB	NABE	MOZZO	
034	H0507280	001	SUPPORT	SUPPORT	TRAEGER	SUPPORTO	
035	H0507290	001	SUPPORT	SUPPORT	TRAEGER	SUPPORTO	
036	H0507340	001	CAPOT	HOOD	HAUBE	COFANO	
037	H0507350	002	PION	PIN, GUIDE	PABSTIFT		
038	H0507370	001	AXE	PIN	ACHSE	ASSE	
039	H0505030	005	CALE	SHIM	DISTANZPLATTE	SPESSORE	

Адрес: (050)-407-68-47
 (050)-407-68-45

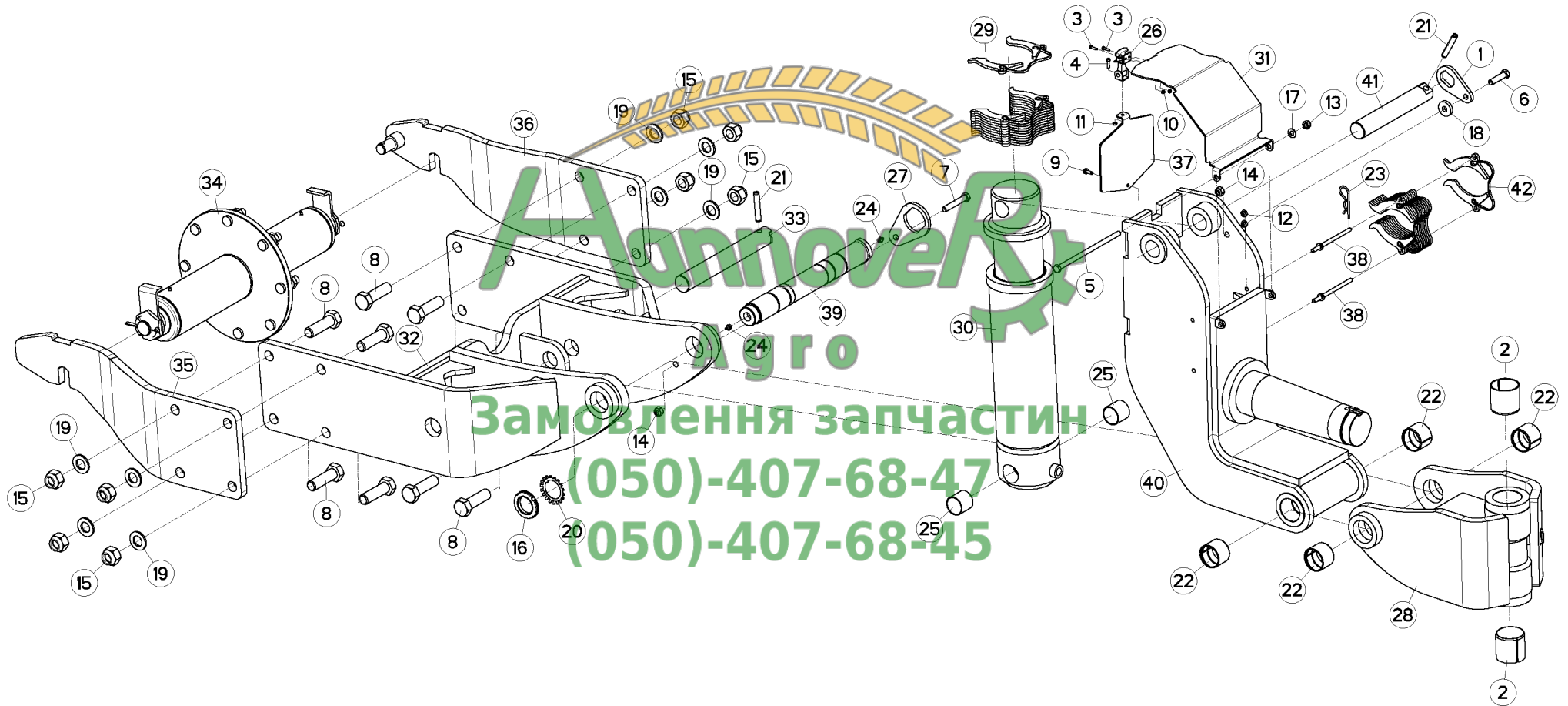



SUPPORT DE ROUE MLD

WHEEL SUPPORT MLD

RADHALTERUNG MLD

SUPPORTO RUOTA MLD

Rep	Nr	Qt	Designation	Description	Bezeichnung	Referenza	Remarque - Remark - Bemerkung - Osservazioni
001	212239	001	PLAQUETTE ARRETOIR	STOP PLATE	ARRETIERUNGSBLECH	PLACHETTA	
002	951521	002	BAGUE ELASTIQUE	TENSION BUSH	EINSPANNBUECHSE	SPINA ELASTICA	
003	80060416	002	VIS TETE HEXAGONALE FE/ZNXC3	HEXAGON HEAD SCREW FE/ZNXC3	SECHSKANTSCHRAUBE FE/ZNXC3	VITE TESTA ESAGONALE FE/ZNXC3	
004	80060518	001	VIS TETE HEXAGONALE FE/ZNXC3	HEXAGON HEAD SCREW FE/ZNXC3	SECHSKANTSCHRAUBE FE/ZNXC3	VITE TESTA ESAGONALE FE/ZNXC3	
005	80061090	001	VIS TETE HEXAGONALE FE/ZNXC3	HEXAGON HEAD SCREW FE/ZNXC3	SECHSKANTSCHRAUBE FE/ZNXC3	VITE TESTA ESAGONALE FE/ZNXC3	
006	80061250	001	VIS TETE HEXAGONALE	HEXAGON HEAD SCREW	SECHSKANTSCHRAUBE	VITE A TESTA ESAGONALE	
007	80061255	001	VIS TETE HEXAGONALE	HEXAGON HEAD SCREW	SECHSKANTSCHRAUBE	VITE A TESTA ESAGONALE	
008	80062480	008	VIS TETE HEXAGONALE FE/ZNXC3	HEXAGON HEAD SCREW FE/ZNXC3	SECHSKANTSCHRAUBE FE/ZNXC3	VITE TESTA ESAGONALE FE/ZNXC3	
009	80190616	001	VIS A TOLE TETE H FE/ZNXC3	HEXAGON HEAD TAPPING SCREWS	SECHSKANT-BLECHSCHRAUBEN		
010	80200440	002	ECROU HEX.AUTOFREINE FE/ZNXC3	SELF-LOCKING NUT FE/ZNXC3	SELBSTSICHERNDE MUTT.FE/ZNXC3	DADO AUTOBLOCCANTE FE/ZNXC3	
011	80200540	001	ECROU HEX.BAS AUTOFR.FE/ZNXC3	SELF-LOCKING NUT FE/ZNXC3	SELBSTSICHERND.MUTTER FE/ZNXC3	DADO AUTOBLOCCANTE FE/ZNXC3	
012	80200840	002	ECROU HEX.BAS AUTOFR.FE/ZNXC3	SELF-LOCKING NUT FE/ZNXC3	SELBSTSICHERND.MUTTER FE/ZNXC3	DADO AUTOBLOCCANTE FE/ZNXC3	
013	80201030	001	ECROU HEX.AUTOFREINE FE/ZNXC3	SELF-LOCKING NUT FE/ZNXC3	SELBSTSICH.MUTTER FE/ZNXC3	DADO AUTOBLOCCANTE FE/ZNXC3	
014	80201240	002	ECROU HEX.BAS AUTOFR.FE/ZNXC3	SELF-LOCKING NUT FE/ZNXC3	SELBSTSICHERND.MUTTER FE/ZNXC3	DADO AUTOBLOCCANTE FE/ZNXC3	
015	80202447	008	ECROU HEXA.AUTOFREINE FE/ZNXC3	SELF-LOCKING NUT FE/ZNXC3	SELBSTSICHERNDE MUTT.FE/ZNXC3	DADO AUTOBLOCCANTE FE/ZNXC3	
016	80204517	001	ECROU A ENCOCHES	SLOTTED ROUND NUT	NUTMUTTER	DADO	
017	80251021	001	RONDELLE PLATE FE/ZNXC3	PLAIN WASHER FE/ZNXC3	SCHEIBE FE/ZNXC3	RONDELLA PIATTA FE/ZNXC3	
018	80251336	001	RONDELLE PLATE FE/ZNXC3	PLAIN WASHER FE/ZNXC3	SCHEIBE FE/ZNXC3	RONDELLA PIATTA FE/ZNXC3	
019	80252432	008	RONDELLE PLATE FE/ZNXC3	PLAIN WASHER FE/ZNXC3	SCHEIBE FE/ZNXC3	RONDELLA PIATTA FE/ZNXC3	
020	80294519	001	RONDELLE-FREIN	TAB WASHER	SICHERUNGSBLECH	RONDELLA-FRENO	
021	80441270	002	GOUPILLE SPIRALE	ROLL PIN	SPIRAL SPANNSTIFTE	SPINA ELASTICA	
022	80471000	004	BAGUE ELASTIQUE	TENSION BUSH	EINSPANNBUECHSE	SPINA ELASTICA	
023	80570477	001	GOUPILLE BETA SIMPLE FE/ZNXC3	SPRING COTTER PIN FE/ZNXC3	FEDERSTECKER FE/ZNXC3	MOLLA FE/ZNXC3	
024	82201016	002	GRAISSEUR AUTOTARAUDANT	SELF TAPPING GREASE NIPPLE	GEWINDESCHNEID-SCHMIERNIPPEL	INGRASSATORE	
025	83014043	002	BAGUE ROULEE	WRAPPED BUSH	GEROLLTE BUECHSE	ANELLO LUBRIFICATO	
026	A7200102	001	ATTACHE	SUPPORT	HALTERUNG	ATTACCO	
027	H0104240	001	PLAQUETTE	PLATE	PLATTE	PLACHETTA	
028	H0206970	001	CARDAN	JOINT, UNIVERSAL	KREUZGELENK	CARDANO	
029	H0505030	003	CALE	SHIM	DISTANZPLATTE	SPESSORE	
030	H0505130	001	VERIN	CYLINDER, HYDRAULIC	HYDRAULIKZYLINDER	CILINDRO	
031	H0505180	001	COUVERCLE	LID	DECKEL	COPERCHIO	
032	H0507110	001	FOURCHE	TINE, MULTIPLE	ZINKEN	FORCA	
033	H0507130	001	AXE	PIN	ACHSE	ASSE	
034	H0507250	001	MOYEU	HUB	NABE	MOZZO	
035	H0507280	001	SUPPORT	SUPPORT	TRAEGER	SUPPORTO	
036	H0507290	001	SUPPORT	SUPPORT	TRAEGER	SUPPORTO	
037	H0507340	001	CAPOT	HOOD	HAUBE	COFANO	
038	H0507350	002	PION	PIN, GUIDE	PABSTIFT		
039	H0507370	001	AXE	PIN	ACHSE	ASSE	
040	H0508300	001	SUPPORT	SUPPORT	TRAEGER	SUPPORTO	
041	H0508310	001	AXE	PIN	ACHSE	ASSE	
042	H0505030	015	CALE	SHIM	DISTANZPLATTE	SPESSORE	

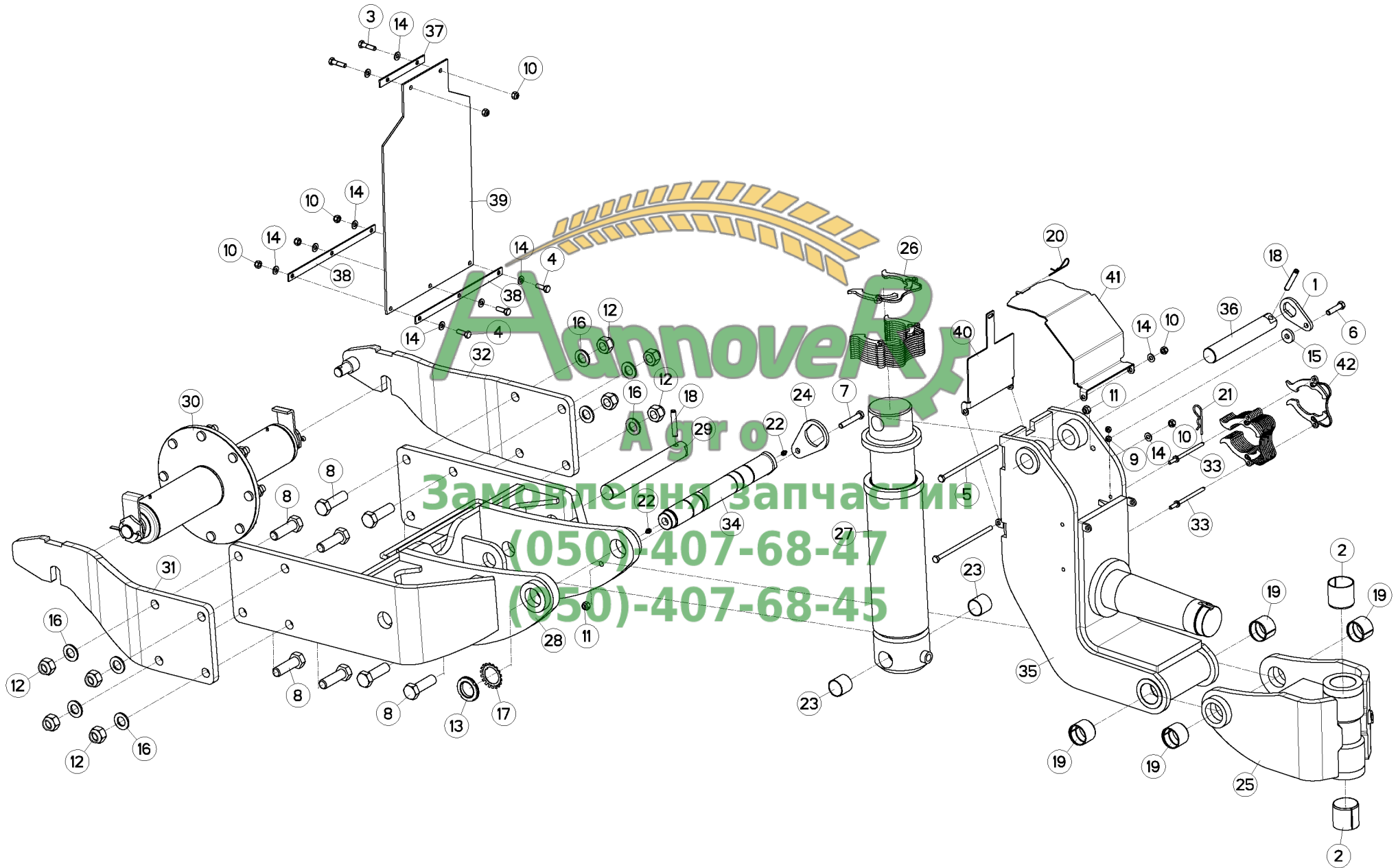



SUPPORT DE ROUE MLD VLD

WHEEL SUPPORT MLD VLD

RADHALTERUNG MLD VLD

SUPPORTO RUOTA MLD VLD

Rep	Nr	Qt	Designation	Description	Bezeichnung	Referenza	Remarque - Remark - Bemerkung - Osservazioni
001	212239	001	PLAQUETTE ARRETOIR	STOP PLATE	ARRETIERUNGSBLECH	PLACHETTA	
002	951521	002	BAGUE ELASTIQUE	TENSION BUSH	EINSPANNBUECHSE	SPINA ELASTICA	
003	80061040	002	VIS TETE HEXAGONALE FE/ZNXC3	HEXAGON HEAD SCREW FE/ZNXC3	SECHSKANTSCHRAUBE FE/ZNXC3	VITE TESTA ESAGONALE FE/ZNXC3	
004	80061073	003	VIS TETE HEXAGONALE FE/ZNXC3	HEXAGON HEAD SCREW FE/ZNXC3	SECHSKANTSCHRAUBE FE/ZNXC3	VITE TESTA ESAGONALE FE/ZNXC3	
005	80061090	002	VIS TETE HEXAGONALE FE/ZNXC3	HEXAGON HEAD SCREW FE/ZNXC3	SECHSKANTSCHRAUBE FE/ZNXC3	VITE TESTA ESAGONALE FE/ZNXC3	
006	80061250	001	VIS TETE HEXAGONALE	HEXAGON HEAD SCREW	SECHSKANTSCHRAUBE	VITE A TESTA ESAGONALE	
007	80061255	001	VIS TETE HEXAGONALE	HEXAGON HEAD SCREW	SECHSKANTSCHRAUBE	VITE A TESTA ESAGONALE	
008	80062480	008	VIS TETE HEXAGONALE FE/ZNXC3	HEXAGON HEAD SCREW FE/ZNXC3	SECHSKANTSCHRAUBE FE/ZNXC3	VITE TESTA ESAGONALE FE/ZNXC3	
009	80200840	002	ECROU HEX.BAS AUTOFR.FE/ZNXC3	SELF-LOCKING NUT FE/ZNXC3	SELBSTSICHERND.MUTTER FE/ZNXC3	DADO AUTOBLOCCANTE FE/ZNXC3	
010	80201030	007	ECROU HEX.AUTOFREINE FE/ZNXC3	SELF-LOCKING NUT FE/ZNXC3	SELBSTSICH.MUTTER FE/ZNXC3	DADO AUTOBLOCCANTE FE/ZNXC3	
011	80201240	002	ECROU HEX.BAS AUTOFR.FE/ZNXC3	SELF-LOCKING NUT FE/ZNXC3	SELBSTSICHERND.MUTTER FE/ZNXC3	DADO AUTOBLOCCANTE FE/ZNXC3	
012	80202447	008	ECROU HEXA.AUTOFREINE FE/ZNXC3	SELF-LOCKING NUT FE/ZNXC3	SELBSTSICHERNDE MUTT.FE/ZNXC3	DADO AUTOBLOCCANTE FE/ZNXC3	
013	80204517	001	ECROU A ENCOCHES	SLOTTED ROUND NUT	NUTMUTTER	DADO	
014	80251021	010	RONDELLE PLATE FE/ZNXC3	PLAIN WASHER FE/ZNXC3	SCHIEBE FE/ZNXC3	RONDELLA PIATTA FE/ZNXC3	
015	80251336	001	RONDELLE PLATE FE/ZNXC3	PLAIN WASHER FE/ZNXC3	SCHIEBE FE/ZNXC3	RONDELLA PIATTA FE/ZNXC3	
016	80252432	008	RONDELLE PLATE FE/ZNXC3	PLAIN WASHER FE/ZNXC3	SCHIEBE FE/ZNXC3	RONDELLA PIATTA FE/ZNXC3	
017	80294519	001	RONDELLE-FREIN	TAB WASHER	SICHERUNGSBLECH	RONDELLA-FRENO	
018	80441270	002	GOUPILLE SPIRALE	ROLL PIN	SPIRAL SPANNSTIFTE	SPINA ELASTICA	
019	80471000	004	BAGUE ELASTIQUE	TENSION BUSH	EINSPANNBUECHSE	SPINA ELASTICA	
020	80570201	001	GOUPILLE BETA FE/ZNXC3	SPRING COTTER PIN FE/ZNXC3	FEDERSTECKER FE/ZNXC3	MOLLA FE/ZNXC3	
021	80570477	001	GOUPILLE BETA SIMPLE FE/ZNXC3	SPRING COTTER PIN FE/ZNXC3	FEDERSTECKER FE/ZNXC3	MOLLA FE/ZNXC3	
022	82201016	002	GRAISSEUR AUTOTARAUDANT	SELF TAPPING GREASE NIPPLE	GEWINDESCHNEID-SCHMIERNIPPEL	INGRASSATORE	
023	83014043	002	BAGUE ROULEE	WRAPPED BUSH	GEROLLTE BUCHSE	ANELLO LUBRIFICATO	
024	H0104240	001	PLAQUETTE	PLATE	PLATTE	PLACHETTA	
025	H0206970	001	CARDAN	JOINT, UNIVERSAL	KREUZGELENK	CARDANO	
026	H0505030	011	CALE	SHIM	DISTANZPLATTE	SPESSORE	
027	H0505130	001	VERIN	CYLINDER, HYDRAULIC	HYDRAULIKZYLINDER	CILINDRO	
028	H0507110	001	FOURCHE	TINE, MULTIPLE	ZINKEN	FORCA	
029	H0507130	001	AXE	PIN	ACHSE	ASSE	
030	H0507250	001	MOYEU	HUB	NABE	MOZZO	
031	H0507280	001	SUPPORT	SUPPORT	TRAEGER	SUPPORTO	
032	H0507290	001	SUPPORT	SUPPORT	TRAEGER	SUPPORTO	
033	H0507350	002	PION	PIN, GUIDE	PABSTIFT		
034	H0507370	001	AXE	PIN	ACHSE	ASSE	
035	H0508300	001	SUPPORT	SUPPORT	TRAEGER	SUPPORTO	
036	H0508310	001	AXE	PIN	ACHSE	ASSE	
037	H0509440	001	TOLE	SHEET	BLECH	TELA	
038	H0509450	002	TOLE	SHEET	BLECH	TELA	
039	H0509460	001	BAVETTE	FLAP	SCHUTZLAPPEN	PARASPRUZZI	
040	H0509540	001	CAPOT	HOOD	HAUBE	COFANO	
041	H0509560	001	CAPOT	HOOD	HAUBE	COFANO	
042	H0505030	009	CALE	SHIM	DISTANZPLATTE	SPESSORE	

(050)-407-68-47
(050)-407-68-45





HYDRAULIQUE DE RELEVAGE

LIFTING HYDRAULIC

HYDRAULIKELEMENTE AUSHEBUNG

SIST. IDRAULICO SOLLEVAMENTO

Rep	Nr	Qt	Designation	Description	Bezeichnung	Referenza	Remarque - Remark - Bemerkung - Osservazioni
001	951212	001	BAGUE	BUSHING	HUELSE	BOCCOLA	
002	951409	001	BLOC	BLOCK	BLOCK	BLOCCO	
003	80060820	002	VIS TETE HEXAGONALE FE/ZNXC3	HEXAGON HEAD SCREW FE/ZNXC3	SECHSKANTSCHRAUBE FE/ZNXC3	VITE TESTA ESAGONALE FE/ZNXC3	
004	80061073	002	VIS TETE HEXAGONALE FE/ZNXC3	HEXAGON HEAD SCREW FE/ZNXC3	SECHSKANTSCHRAUBE FE/ZNXC3	VITE TESTA ESAGONALE FE/ZNXC3	
005	80080626	014	VIS TETE CYL.SIX P.CR.FE/ZNXC3	SCREW, SOCKET HEAD FE/ZNXC3	ZYLINDERSCHR.INNENSEC.FE/ZNXC3	VITE A TESTA CILINDR. FE/ZNXC3	
006	80270803	002	RONDELLE GROWER FE/ZNXC3	SPRING LOCK WASHER FE/ZNXC3	FEDERRING FE/ZNXC3	RONDELLA GROWER FE/ZNXC3	
007	80271003	002	RONDELLE GROWER FE/ZNXC3	SPRING LOCK WASHER FE/ZNXC3	FEDERRING FE/ZNXC3	RONDELLA GROWER FE/ZNXC3	
008	82300026	001	CAPUCHON COUPLEUR MALE	CAP MALE CONNECTOR	KAPPE KUPPLUNGSSTECKER	TAPPO	
009	83090093	001	COLLIER PLASTIQUE	CABLE TIE PLASTIC	KABELBINDER PLASTIK	FASCETTA	
010	A4061815	001	BOUCHON	PLUG	VERSCHLUSSSCHRAUBE	TAPPO	
011	A4072010	001	LIMITEUR DEBIT D2 TUBE D14	DELIVERY LIMITER	MENGENBEGRENZER	REGOLATORE D'ALIMENTAZIONE	
012	A4074018	001	COUPLEUR MALE	CONNECTOR MALE	KUPPLUNGSTECKER	ATTACCO IDRAULICO	
013	A4075005	001	ROBINET	VALVE, BALL	KUGELHAHN	ROBINETTO	
014	A4080306	004	UNION DOUBLE FE/ZNXC3	STRAIGHT COUPLING FE/ZNXC3	GERADE VERSCHRAUBUNG FE/ZNXC3	GIUNZIONE DIRITTA FE/ZNXC3	
015	A4080429	005	UNION MALE	MALE STUD CONNECTOR	GERADER EINSCHRAUBSTUTZEN	GIUNZIONE DIRITTA ZBC	
016	A4080430	002	UNION MALE	MALE STUD CONNECTOR	GERADER EINSCHRAUBSTUTZEN	GIUNZIONE DIRITTA ZBC	
017	A4080502	001	ADAPTATEUR ZBC	ADAPTER ZBC	GEWINDESTUTZEN ZBC	ADATTATORE ZBC	
018	A4081304	001	BANJO NU ZBC	BANJO COUPLING ZBC	SCHWENKVERSCHRAUBUNG ZBC	ANNELLO ORIENTABILE	
019	A7260029	007	COLLIER SIMPLE D22 NU	CLAMP D.22	SHELLE D.22	COLLARE D.22	
020	A4923011	001	FLEXIBLE HYDRAULIQUE	HYDRAULIC HOSE	HYDRAULIKSCHLAUCH	TUBO GOMMA	<->450 mm
021	A4923015	001	FLEXIBLE HYDRAULIQUE	HYDRAULIC HOSE	HYDRAULIKSCHLAUCH	TUBO GOMMA	<->1050 mm
022	A4923015	001	FLEXIBLE HYDRAULIQUE	HYDRAULIC HOSE	HYDRAULIKSCHLAUCH	TUBO GOMMA	<->1050 mm
023	A4923030	001	FLEXIBLE HYDRAULIQUE	HYDRAULIC HOSE	HYDRAULIKSCHLAUCH	TUBO GOMMA	<->650 mm
024	A4923045	001	FLEXIBLE HYDRAULIQUE	HYDRAULIC HOSE	HYDRAULIKSCHLAUCH	TUBO GOMMA	<->700 mm
025	A4923047	001	FLEXIBLE HYDRAULIQUE	HYDRAULIC HOSE	HYDRAULIKSCHLAUCH	TUBO GOMMA	<->2700 mm
026	A4923066	001	FLEXIBLE HYDRAULIQUE	HYDRAULIC HOSE	HYDRAULIKSCHLAUCH	TUBO GOMMA	<->1500 mm
027	A4923076	001	FLEXIBLE HYDRAULIQUE	HYDRAULIC HOSE	HYDRAULIKSCHLAUCH	TUBO GOMMA	<->800 mm
028	H0505130	001	VERIN	CYLINDER, HYDRAULIC	HYDRAULIKZYLINDER	CILINDRO	
029	H0505160	001	POCHETTE	KIT, SEAL	TACHE	SACCHE	: H0505130
030	H0600140	001	ENSEMBLE BLOC + ACCU	BLOCK	BLOCK	BLOCCO	

Автомобильная техника
 (050)-407-68-47
 (050)-407-68-45





HYDRAULIQUE DE RELEVAGE

LIFTING HYDRAULIC

HYDRAULIKELEMENTE AUSHEBUNG

SIST. IDRAULICO SOLLEVAMENTO

Rep	Nr	Qt	Designation	Description	Bezeichnung	Referenza	Remarque - Remark - Bemerkung - Osservazioni
001	951212	001	BAGUE	BUSHING	HUELSE	BOCCOLA	
002	951409	001	BLOC	BLOCK	BLOCK	BLOCCO	
003	80060612	012	VIS TETE HEXAGONALE FE/ZNXC3	HEXAGON HEAD SCREW FE/ZNXC3	SECHSKANTSCHRAUBE FE/ZNXC3	VITE TESTA ESAGONALE FE/ZNXC3	
004	80060635	008	VIS TETE HEXAGONALE FE/ZNXC3	HEXAGON HEAD SCREW FE/ZNXC3	SECHSKANTSCHRAUBE FE/ZNXC3	VITE TESTA ESAGONALE FE/ZNXC3	
005	80060820	002	VIS TETE HEXAGONALE FE/ZNXC3	HEXAGON HEAD SCREW FE/ZNXC3	SECHSKANTSCHRAUBE FE/ZNXC3	VITE TESTA ESAGONALE FE/ZNXC3	
006	80061073	002	VIS TETE HEXAGONALE FE/ZNXC3	HEXAGON HEAD SCREW FE/ZNXC3	SECHSKANTSCHRAUBE FE/ZNXC3	VITE TESTA ESAGONALE FE/ZNXC3	
007	80080626	004	VIS TETE CYL.SIX P.CR.FE/ZNXC3	SCREW, SOCKET HEAD FE/ZNXC3	ZYLINDERSCHR.INNENSEC.FE/ZNXC3	VITE A TESTA CILINDR. FE/ZNXC3	
008	80250611	008	RONDELLE PLATE FE/ZNXC3	PLAIN WASHER FE/ZNXC3	SCHEIBE FE/ZNXC3	RONDELLA PIATTA FE/ZNXC3	
009	82300026	001	CAPUCHON COUPLEUR MALE	CAP MALE CONNECTOR	KAPPE KUPPLUNGSSTECKER	TAPPO	
010	80270803	002	RONDELLE GROWER FE/ZNXC3	SPRING LOCK WASHER FE/ZNXC3	FEDERRING FE/ZNXC3	RONDELLA GROWER FE/ZNXC3	
011	80271003	002	RONDELLE GROWER FE/ZNXC3	SPRING LOCK WASHER FE/ZNXC3	FEDERRING FE/ZNXC3	RONDELLA GROWER FE/ZNXC3	
012	83090093	001	COLLIER PLASTIQUE	CABLE TIE PLASTIC	KABELBINDER PLASTIK	FASCETTA	
013	A4061815	001	BOUCHON	PLUG	VERSCHLUSSSCHRAUBE	TAPPO	
014	A4072010	002	LIMITEUR DEBIT D2 TUBE D14	DELIVERY LIMITER	MENGENBEGRENZER	REGOLATORE D'ALIMENTAZIONE	
015	A4074018	001	COUPLEUR MALE	CONNECTOR MALE	KUPPLUNGSTECKER	ATTACCO IDRAULICO	
016	A4075005	001	ROBINET	VALVE, BALL	KUGELHAHN	ROBINETTO	
017	A4080306	004	UNION DOUBLE FE/ZNXC3	STRAIGHT COUPLING FE/ZNXC3	GERADE VERSCHRAUBUNG FE/ZNXC3	GIUNZIONE DIRITTA FE/ZNXC3	
018	A4080411	001	UNION MALE	MALE STUD CONNECTOR	GERADER EINSCHRAUBSTUTZEN	GIUZIONE DIRITTA ZBC	
019	A4080429	004	UNION MALE	MALE STUD CONNECTOR	GERADER EINSCHRAUBSTUTZEN	GIUZIONE DIRITTA ZBC	
020	A4080430	002	UNION MALE	MALE STUD CONNECTOR	GERADER EINSCHRAUBSTUTZEN	GIUZIONE DIRITTA ZBC	
021	A4080513	001	ADAPTATEUR MALE	SWIVEL CONNECTOR	EINSTELBARE EINSCHRAUBSTUTZE	ADATTATORE ZBC	
022	A4081304	001	BANJO NU ZBC	BANJO COUPLING ZBC	SCHWENKVERSCHRAUBUNG ZBC	ANNELLO ORIENTABILE	
023	A4082732	001	COUDE TOURNANT	AJUSTABLE MALE STUD ELBOW	EINSTELLBARE WINKEL STUTZEN	GIUNZIONE A 45°ORIENTABILE ZBC	
024	A7260029	006	COLLIER SIMPLE D22 NU	CLAMP D.22	SCHELLE D.22	COLLARE D.22	
025	A4923011	001	FLEXIBLE HYDRAULIQUE	HYDRAULIC HOSE	HYDRAULIKSCHLAUCH	TUBO GOMMA	<->450 mm
026	A4923015	001	FLEXIBLE HYDRAULIQUE	HYDRAULIC HOSE	HYDRAULIKSCHLAUCH	TUBO GOMMA	<->1050 mm
027	A4923015	001	FLEXIBLE HYDRAULIQUE	HYDRAULIC HOSE	HYDRAULIKSCHLAUCH	TUBO GOMMA	<->1050 mm
028	A4923030	001	FLEXIBLE HYDRAULIQUE	HYDRAULIC HOSE	HYDRAULIKSCHLAUCH	TUBO GOMMA	<->650 mm
029	A4923045	001	FLEXIBLE HYDRAULIQUE	HYDRAULIC HOSE	HYDRAULIKSCHLAUCH	TUBO GOMMA	<->700 mm
030	A4923047	001	FLEXIBLE HYDRAULIQUE	HYDRAULIC HOSE	HYDRAULIKSCHLAUCH	TUBO GOMMA	<->2700 mm
031	A4923066	001	FLEXIBLE HYDRAULIQUE	HYDRAULIC HOSE	HYDRAULIKSCHLAUCH	TUBO GOMMA	<->1500 mm
032	A4923070	001	FLEXIBLE HYDRAULIQUE	HYDRAULIC HOSE	HYDRAULIKSCHLAUCH	TUBO GOMMA	<->500 mm
033	H0206630	004	PONTET	BRIDGE	ABZUGSBUGEL		
034	H0505130	001	VERIN	CYLINDER, HYDRAULIC	HYDRAULIKZYLINDER	CILINDRO	
035	H0505160	001	POCHETTE	KIT, SEAL	TACHE	SACCHE	
036	H0600140	001	ENSEMBLE BLOC + ACCU	BLOCK	BLOCK	BLOCCO	

(050)-407-68-47
(050)-407-68-45

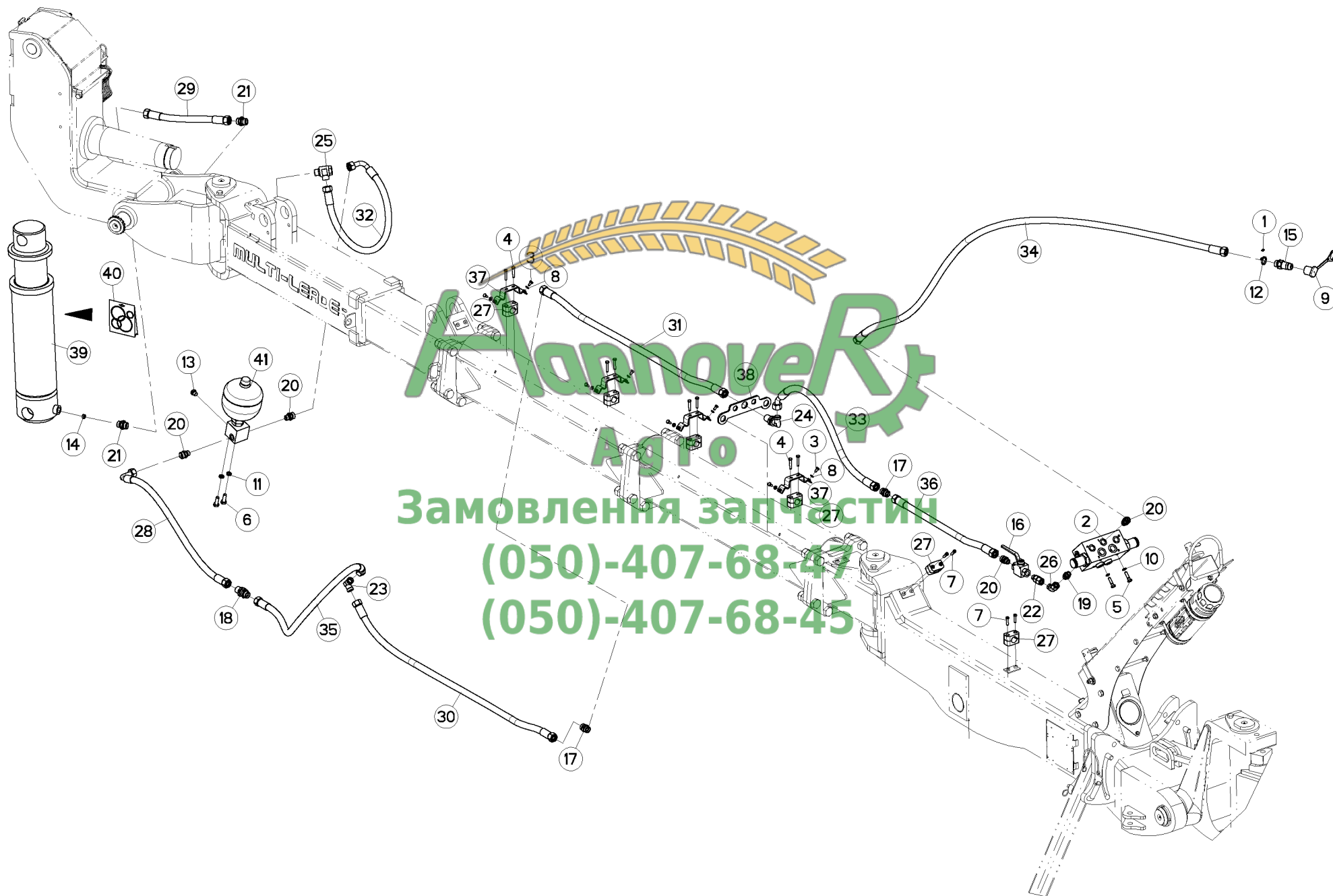



HYDRAULIQUE DE RELEVAGE

LIFTING HYDRAULIC

HYDRAULIKELEMENTE AUSHEBUNG

SIST. IDRAULICO SOLLEVAMENTO

Rep	Nr	Qt	Designation	Description	Bezeichnung	Referenza	Remarque - Remark - Bemerkung - Osservazioni
001	951212	001	BAGUE	BUSHING	HUELSE	BOCCOLA	
002	951409	001	BLOC	BLOCK	BLOCK	BLOCCO	
003	80060612	012	VIS TETE HEXAGONALE FE/ZNXC3	HEXAGON HEAD SCREW FE/ZNXC3	SECHSKANTSCHRAUBE FE/ZNXC3	VITE TESTA ESAGONALE FE/ZNXC3	
004	80060635	008	VIS TETE HEXAGONALE FE/ZNXC3	HEXAGON HEAD SCREW FE/ZNXC3	SECHSKANTSCHRAUBE FE/ZNXC3	VITE TESTA ESAGONALE FE/ZNXC3	
005	80060830	002	VIS TETE HEXAGONALE FE/ZNXC3	HEXAGON HEAD SCREW FE/ZNXC3	SECHSKANTSCHRAUBE FE/ZNXC3	VITE TESTA ESAGONALE FE/ZNXC3	
006	80061073	002	VIS TETE HEXAGONALE FE/ZNXC3	HEXAGON HEAD SCREW FE/ZNXC3	SECHSKANTSCHRAUBE FE/ZNXC3	VITE TESTA ESAGONALE FE/ZNXC3	
007	80080626	004	VIS TETE CYL.SIX P.CR.FE/ZNXC3	SCREW, SOCKET HEAD FE/ZNXC3	ZYLINDERSCHR.INNENSEC.FE/ZNXC3	VITE A TESTA CILINDR. FE/ZNXC3	
008	80250611	008	RONDELLE PLATE FE/ZNXC3	PLAIN WASHER FE/ZNXC3	SCHEIBE FE/ZNXC3	RONDELLA PIATTA FE/ZNXC3	
009	82300026	001	CAPUCHON COUPLEUR MALE	CAP MALE CONNECTOR	KAPPE KUPPLUNGSSTECKER	TAPPO	
010	80270803	002	RONDELLE GROWER FE/ZNXC3	SPRING LOCK WASHER FE/ZNXC3	FEDERRING FE/ZNXC3	RONDELLA GROWER FE/ZNXC3	
011	80271003	002	RONDELLE GROWER FE/ZNXC3	SPRING LOCK WASHER FE/ZNXC3	FEDERRING FE/ZNXC3	RONDELLA GROWER FE/ZNXC3	
012	83090093	001	COLLIER PLASTIQUE	CABLE TIE PLASTIC	KABELBINDER PLASTIK	FASCETTA	
013	A4061815	001	BOUCHON	PLUG	VERSCHLUSSSCHRAUBE	TAPPO	
014	A4072010	002	LIMITEUR DEBIT D2 TUBE D14	DELIVERY LIMITER	MENGENBEGRENZER	REGOLATORE D'ALIMENTAZIONE	
015	A4074018	001	COUPLEUR MALE	CONNECTOR MALE	KUPPLUNGSTECKER	ATTACCO IDRAULICO	
016	A4075005	001	ROBINET	VALVE, BALL	KUGELHAHN	ROBINETTO	
017	A4080306	002	UNION DOUBLE FE/ZNXC3	STRAIGHT COUPLING FE/ZNXC3	GERADE VERSCHRAUBUNG FE/ZNXC3	GIUNZIONE DIRITTA FE/ZNXC3	
018	A4080315	001	UNION DOUBLE / CLOISON	BULKHEAD UNION	VERBINDUNGSNIPEL	CONNETTORE	
019	A4080411	001	UNION MALE	MALE STUD CONNECTOR	GERADER EINSCHRAUBSTUTZEN	GIUZIONE DIRITTA ZBC	
020	A4080429	004	UNION MALE	MALE STUD CONNECTOR	GERADER EINSCHRAUBSTUTZEN	GIUZIONE DIRITTA ZBC	
021	A4080430	002	UNION MALE	MALE STUD CONNECTOR	GERADER EINSCHRAUBSTUTZEN	GIUZIONE DIRITTA ZBC	
022	A4080513	001	ADAPTATEUR MALE	SWIVEL CONNECTOR	EINSTELBARE EINSCHRAUBSTUTZE	ADATTATORE ZBC	
023	A4080702	001	COUDE EGAL FE/ZNXC3	ELBOW FE/ZNXC3	WINKEL-VERSCHRAUBUNG FE/ZNXC3	GOMITO FE/ZNXC3	
024	A4080751	001	COUDE EGAL/CLOISON FE/ZNXC3	BULKHEAD ELBOW FE/ZNXC3	WINKEL-SCHOTTVERSCHRAUBUNG	GOMITO ATTRAVERSAMENT.FE/ZNXC3	
025	A4081304	001	BANJO NU ZBC	BANJO COUPLING ZBC	SCHWENKVERSCHRAUBUNG ZBC	ANNELLO ORIENTABILE	
026	A4082732	001	COUDE TOURNANT	AJUSTABLE MALE STUD ELBOW	EINSTELLBARE WINKEL STUTZEN	GIUNZIONE A 45°ORIENTABILE ZBC	
027	A7260029	006	COLLIER SIMPLE D22 NU	CLAMP D.22	SHELLE D.22	COLLARE D.22	
028	A4922070	001	FLEXIBLE HYDRAULIQUE	HYDRAULIC HOSE	HYDRAULIKSCHLAUCH	TUBO GOMMA	<->700 mm
029	A4923011	001	FLEXIBLE HYDRAULIQUE	HYDRAULIC HOSE	HYDRAULIKSCHLAUCH	TUBO GOMMA	<->450 mm
030	A4923015	001	FLEXIBLE HYDRAULIQUE	HYDRAULIC HOSE	HYDRAULIKSCHLAUCH	TUBO GOMMA	<->1050 mm
031	A4923015	001	FLEXIBLE HYDRAULIQUE	HYDRAULIC HOSE	HYDRAULIKSCHLAUCH	TUBO GOMMA	<->1050 mm
032	A4923030	001	FLEXIBLE HYDRAULIQUE	HYDRAULIC HOSE	HYDRAULIKSCHLAUCH	TUBO GOMMA	<->650 mm
033	A4923045	001	FLEXIBLE HYDRAULIQUE	HYDRAULIC HOSE	HYDRAULIKSCHLAUCH	TUBO GOMMA	<->700 mm
034	A4923047	001	FLEXIBLE HYDRAULIQUE	HYDRAULIC HOSE	HYDRAULIKSCHLAUCH	TUBO GOMMA	<->2700 mm
035	A4923048	001	FLEXIBLE HYDRAULIQUE	HYDRAULIC HOSE	HYDRAULIKSCHLAUCH	TUBO GOMMA	<->3150 mm
036	A4923077	001	FLEXIBLE HYDRAULIQUE	HOSE L=500 D/D 1/2'	SCHLAUCH L=500 D/D 1/2'	TUBO IN GOMMA	<->500 mm
037	H0206630	004	PONTET	BRIDGE	ABZUGSBUGEL		
038	H0208810	001	SUPPORT	SUPPORT	TRAEGER	SUPPORTO	
039	H0505130	001	VERIN	CYLINDER, HYDRAULIC	HYDRAULIKZYLINDER	CILINDRO	
040	H0505160	001	POCHETTE	KIT, SEAL	TACHE	SACCHE	: H0505130
041	H0600140	001	ENSEMBLE BLOC + ACCU	BLOCK	BLOCK	BLOCCO	



Hannover
Агро

Замовлення запчастин
(050)-407-68-47
(050)-407-68-45



MULTI-LEADER T

C0000 >

H05R0103 A

ROUE 500/45X22,5 14PR

WHEEL 500/45X22,5 14PR

RAD 500/45X22,5 14PR

RUOTA 500/45X22,5 14PR

Rep	Nr	Qt	Designation	Description	Bezeichnung	Referenza	Remarque - Remark - Bemerkung - Osservazioni
001	H0502780	001	PNEU	TIRE	REIFEN	PNEUMATICO	
002	H0502790	001	JANTE	WHEEL	FELGE	CERCHIO	
003	H0502800	001	ROUE	WHEEL AND TIRE ASSEMBLY	RAD	RUOTA	3,4 bar (49.31 PSI)
004	H0502810	001	CHAMBRE A AIR	INNER TUBE	SCHLAUCH	CAMERA D'ARIA	



Замовлення запчастин

(050)-407-68-47

(050)-407-68-45





MULTI-LEADER T

C0000 >

H05R0119 A

ROUE D1200-500

WHEEL D1200-500

RAD D1200-500

RUOTA D1200-500

Rep	Nr	Qt	Designation	Description	Bezeichnung	Referenza	Remarque - Remark - Bemerkung - Osservazioni
001	H0505060	001	PNEU	TIRE	REIFEN	PNEUMATICO	[1]
002	H0505070	001	JANTE	WHEEL	FELGE	CERCHIO	[1]
003	H0505080	001	ROUE	WHEEL AND TIRE ASSEMBLY	RAD	RUOTA	+ [1] 4,4 bar (63.82 PSI)



Замовлення запчастин

(050)-407-68-47

(050)-407-68-45





DECROTTOIR

SCRAPER

ABSTREIFER

POLITIRE

Rep	Nr	Qt	Designation	Description	Bezeichnung	Referenza	Remarque - Remark - Bemerkung - Osservazioni
001	80061651	004	VIS TETE HEXAGONALE FE/ZNXC3	HEXAGON HEAD SCREW FE/ZNXC3	SECHSKANTSCHRAUBE FE/ZNXC3	VITE TESTA ESAGONALE FE/ZNXC3	
002	80201640	004	ECROU HEX.BAS AUTOFR.FE/ZNXC3	SELF-LOCKING NUT FE/ZNXC3	SELBSTSICHERND.MUTTER FE/ZNXC3	DADO AUTOBLOCCANTE FE/ZNXC3	
003	80251624	004	RONDELLE PLATE FE/ZNXC3	PLAIN WASHER FE/ZNXC3	SCHEIBE FE/ZNXC3	RONDELLA PIATTA FE/ZNXC3	
004	80252640	004	RONDELLE PLATE FE/ZNXC3	PLAIN WASHER FE/ZNXC3	SCHEIBE FE/ZNXC3	RONDELLA FE/ZNXC3	
005	80451040	004	GOUPILLE ELASTIQUE FLZNNC	ROLL PIN FLZNNC	SPANNHUELSE FLZNNC	SPINA ELASTICA FLZNNC	
006	H0505690	001	TRINGLE	LINK	STREBE	TRIANGOLO	
007	H0505700	001	BIELLETTTE	LINK	SHUBSTANGE		
008	H0505710	001	BIELLETTTE	LINK	SHUBSTANGE		
009	H0505730	001	DECROTTOIR	SCRAPER, DIRT	ABSTREIFER	RASCHIATORE	



Замовлення запчастин

(050)-407-68-47

(050)-407-68-45





BOITIER T

BOX T

GEHAEUSE T

SCATOLA T

Rep	Nr	Qt	Designation	Description	Bezeichnung	Referenza	Remarque - Remark - Bemerkung - Osservazioni
001	421223	003	RONDELLE	WASHER	SCHEIBE	RONDELLA PIATTA	
002	951669	001	VIS	SCREW	SCHRAUBE	VITE	
003	80202421	003	ECROU HEXAG.EMBASE AUTOFR.	SELF-LOCKING NUT	SELBSTSICHERNDE MUTTER	DADO AUTOBLOCCANTE	
004	H0400320	002	VIS SPECIALE	BOLT	SCHRAUBE	VITE	
005	H0405940	001	BOITIER	HOUSING	GEHAEUSE	SCATOLA	
006	H0405950	001	BOITIER	HOUSING	GEHAEUSE	SCATOLA	



Замовлення запчастин

(050)-407-68-47

(050)-407-68-45



AGE SECURITE T80 Q12.9

PLOUGH LEG SAFETY T80 Q12.9

GRINDEL STEINSICHERUN T80 Q12.

BURE DI SICUREZZA T80 Q12.9

Rep	Nr	Qt	Designation	Description	Bezeichnung	Referenza	Remarque - Remark - Bemerkung - Osservazioni
001	445424	004	ENTRETOISE MAST.120/150	SPACER	DISTANZSCHEIBE	BOCCOLA	
002	645280	002	ETANCON	SHANK	TRAGRAHMEN	TELAIO	
003	80062076	004	VIS TETE HEXAGONALE FE/ZNXC3	HEXAGON HEAD SCREW FE/ZNXC3	SECHSKANTSCHRAUBE FE/ZNXC3	VITE TESTA ESAGONALE FE/ZNXC3	
004	80201640	002	ECROU HEX.BAS AUTOFR.FE/ZNXC3	SELF-LOCKING NUT FE/ZNXC3	SELBSTSICHERND.MUTTER FE/ZNXC3	DADO AUTOBLOCCANTE FE/ZNXC3	[1]
005	80201669	002	ECROU HEXAGONAL FE/ZNXC3	NUT FE/ZNXC3	SECHSKANTMUTTER FE/ZNXC3	DADO FE/ZNXC3	[1]
006	80202070	004	ECROU HEXAGONAL FE/ZNXC3	NUT FE/ZNXC3	SECHSKANTMUTTER FE/ZNXC3	DADO FE/ZNXC3	
007	80202720	002	ECROU HEXAG.EMBA.AUTOFR.FLZNNC	SELF-LOCKING NUT FLZNNC	SELBSTSICHERNDE MUTTER FLZNNC	DADO AUTOBLOCCANTE FLZNNC	
008	80202731	006	ECROU HEX.BAS AUTOFR.FLZNNC	SELF-LOCKING NUT FLZNNC	SELBSTSICHERND.MUTTER FLZNNC	DADO AUTOBLOCCANTE FLZNNC	
009	80283680	002	RONDELLE RESSORT	DISC SPRING	TELLERFEDER	RONDELLA A MOLLA	
010	82201016	002	GRAISSEUR AUTOTARAUDANT	SELF TAPPING GREASE NIPPLE	GEWINDESCHNEID-SCHMIERNIPPEL	INGRASSATORE	
011	H0604000	001	BOITE 8 BOULONS SEC.T 16X100	BOX OF 8 BOLTS/NUTS	SCHACHTEL 8 SCHRAUBEN 800616C2	SERIE 8 BULLONI (VITE+DADO)	+ [1]
012	800616C2	002	VIS TETE HEXAGONALE FLZNNC	HEXAGON HEAD SCREW FLZNNC	SECHSKANTSCHRAUBE FLZNNC	VITE TESTA ESAGONALE FLZNNC	[1]
013	80272002	004	RONDELLE GROWER FE/ZNXC3	SPRING LOCK WASHER FE/ZNXC3	FEDERING FE/ZNXC3	RONDELLA GROWER FE/ZNXC3	
014	H0405470	002	NOIX	CRANKTHROW	KURBELWANGE		
015	H0405480	002	AXE	PIN	ACHSE	ASSE	
016	H0405510	002	RONDELLE	WASHER	SCHEIBE	RONDELLA PIATTA	
017	H0405520	001	FLASQUE	FLANGE	FLANSCH	FLANGIA	

Агро
 Агро
 Агро

Замовлення запчастин

(050)-407-68-47

(050)-407-68-45



AGE SECURITE T80 LOS Q12.9

PLOUGH LEG SAFETY T80 LOS Q12.

GRINDEL STEINSICHERUN T80 LOS

BURE DI SICUREZZA T80 LOS Q12.

Rep	Nr	Qt	Designation	Description	Bezeichnung	Referenza	Remarque - Remark - Bemerkung - Osservazioni
001	445424	004	ENTRETOISE MAST.120/150	SPACER	DISTANZSCHEIBE	BOCCOLA	
002	582196	001	SEP ETANCON T LOSANGE D	T DIAMOND FROG-LEG R	T RAUTEN HALTESTIEL R	GAMBA T LOSANGA DX	
003	800616C2	002	VIS TETE HEXAGONALE FLZNNC	HEXAGON HEAD SCREW FLZNNC	SECHSKANTSCHRAUBE FLZNNC	VITE TESTA ESAGONALE FLZNNC	[1]
004	80062076	004	VIS TETE HEXAGONALE FE/ZNXC3	HEXAGON HEAD SCREW FE/ZNXC3	SECHSKANTSCHRAUBE FE/ZNXC3	VITE TESTA ESAGONALE FE/ZNXC3	
005	80201640	002	ECROU HEX.BAS AUTOFR.FE/ZNXC3	SELF-LOCKING NUT FE/ZNXC3	SELBSTSICHERND.MUTTER FE/ZNXC3	DADO AUTOBLOCCANTE FE/ZNXC3	[1]
006	80201669	002	ECROU HEXAGONAL FE/ZNXC3	NUT FE/ZNXC3	SECHSKANTMUTTER FE/ZNXC3	DADO FE/ZNXC3	[1]
007	80202070	004	ECROU HEXAGONAL FE/ZNXC3	NUT FE/ZNXC3	SECHSKANTMUTTER FE/ZNXC3	DADO FE/ZNXC3	
008	80202720	002	ECROU HEXAG.EMBA.AUTOFR.FLZNNC	SELF-LOCKING NUT FLZNNC	SELBSTSICHERNDE MUTTER FLZNNC	DADO AUTOBLOCCANTE FLZNNC	
009	80202731	006	ECROU HEX.BAS AUTOFR.FLZNNC	SELF-LOCKING NUT FLZNNC	SELBSTSICHERND.MUTTER FLZNNC	DADO AUTOBLOCCANTE FLZNNC	
010	80283680	002	RONDELLE RESSORT	DISC SPRING	TELLERFEDER	RONDELLA A MOLLA	
011	82201016	002	GRAISSEUR AUTOTARAUDANT	SELF TAPPING GREASE NIPPLE	GEWINDESCHNEID-SCHMIERNIPPEL	INGRASSATORE	
012	H0604000	001	BOITE 8 BOULONS SEC.T 16X100	BOX OF 8 BOLTS/NUTS	SCHACHTEL 8 SCHRAUBEN 800616C2	SERIE 8 BULLONI (VITE+DADO)	+ [1]
013	582197	001	SEP ETANCON T LOSANGE G	T DIAMOND FROG-LEG L	T RAUTEN HALTESTIEL L	GAMBA T LOSANGA SX	
014	80272002	004	RONDELLE GROWER FE/ZNXC3	SPRING LOCK WASHER FE/ZNXC3	FEDERRING FE/ZNXC3	RONDELLA GROWER FE/ZNXC3	
015	H0405470	002	NOIX	CRANKTHROW	KURBELWANGE		
016	H0405480	002	AXE	PIN	ACHSE	ASSE	
017	H0405510	002	RONDELLE	WASHER	SCHEIBE	RONDELLA PIATTA	
018	H0405520	001	FLASQUE	FLANGE	FLANSCH	FLANGIA	

Замовлення запчастин

(050)-407-68-47

(050)-407-68-45

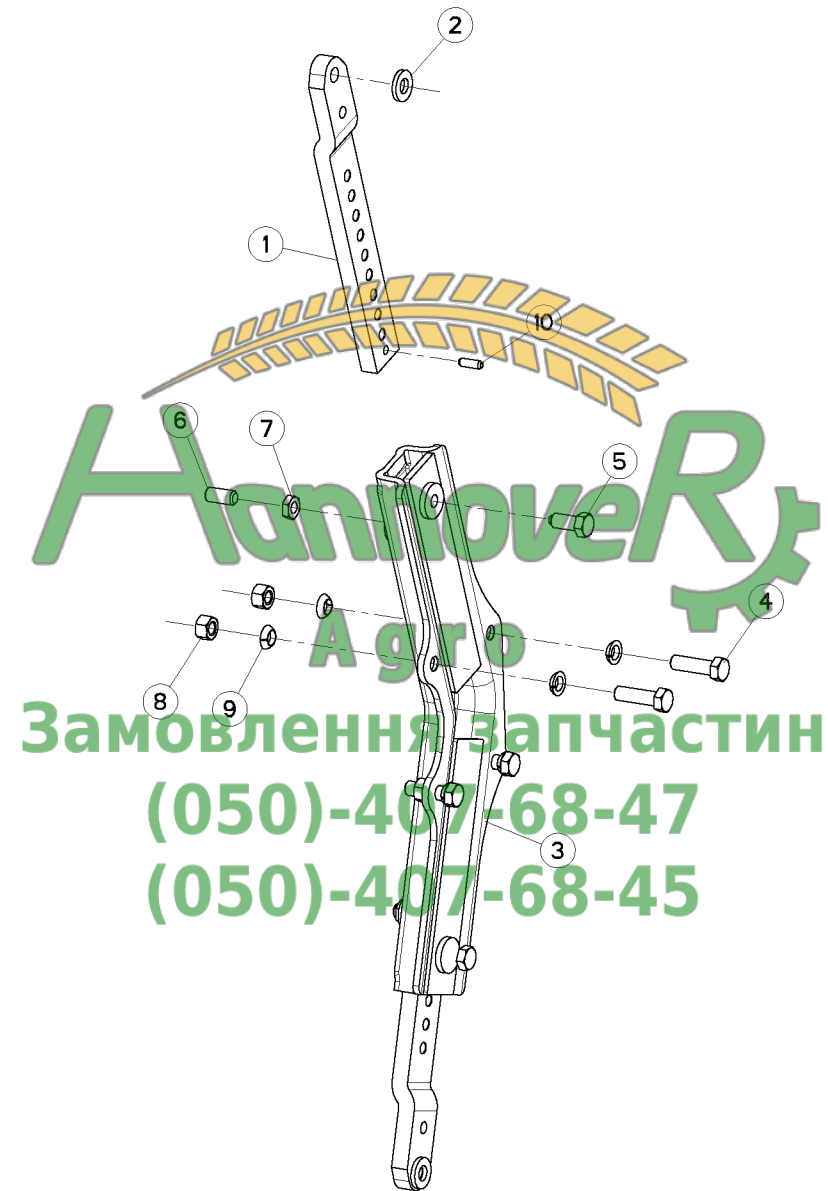



BOITIER TIGES RASETTE

SKIMMER LEG/SUPPORT

HALTERUNG/VORSCHALESTIEL

GAMBO DEL PREVOMERE

Rep	Nr	Qt	Designation	Description	Bezeichnung	Referenza	Remarque - Remark - Bemerkung - Osservazioni
001	261166	002	TIGE DE RASETTE	SKIMMER LEG	STIEL	BRACCIO AVANVOMERE	
002	422069	002	RONDELLE PLATE FE/ZNXC3	WASHER	RING	PARAOLIO	
003	582216	001	BOITIER	HOUSING	GEHAEUSE	SCATOLA	
004	80061647	004	VIS TETE HEXAGONALE FE/ZNXC3	HEXAGON HEAD SCREW FE/ZNXC3	SECHSKANTSCHRAUBE FE/ZNXC3	VITE TESTA ESAGONALE FE/ZNXC3	19daNm 140lbf.ft
005	80091640	002	VIS TETE HEX.B.SPHE.FE/ZNXC3	HEXAGON HEAD SCREW FE/ZNXC3	SECHSKANTSCHRAUBE FE/ZNXC3	VITE TESTA ESAGONALE FE/ZNXC3	
006	80151635	002	VIS S/TETE B.PLAT HC FLZNNC	SOCKET SET SCREW FLZNNC	GEWINDESTIFT FLZNNC	VITE FLZNNC	
007	80201601	002	ECROU HEXAGONAL BAS	HEXAGON THIN NUT	FLACHE SECHSKANTMUTTER	DADO	
008	80201670	004	ECROU HEXAGONAL FE/ZNXC3	NUT FE/ZNXC3	SECHSKANTMUTTER FE/ZNXC3	DADO FE/ZNXC3	
009	80271686	008	RONDELLE RESSORT SP.FLZNNC	SPHERICAL SPRING WASH.FLZNNC	FEDERRING FLZNNC	RONDELLA A MOLLA FLZNNC	
010	80450928	002	GOUPILLE ELASTIQUE FLZNNC	ROLL PIN FLZNNC	SPANNHUELSE FLZNNC	SPINA ELASTICA FLZNNC	



Замовлення запчастин

(050)-407-68-47

(050)-407-68-45





COUTRE CIRCULAIRE Ø500 T

DISC COULTER Ø500 T

SCHEIBENSECH Ø500 T

ASSOLCATORE A DISCO Ø500 T

Rep	Nr	Qt	Designation	Description	Bezeichnung	Referenza	Remarque - Remark - Bemerkung - Osservazioni
001	110029	002	DISQUE CRENELE D 500	NOTCHED DISC D 500	GEZACKTE SCHEIBE D 500	DISCO SCANALATO D 500	
002	110030	002	DISQUE CC DIA500	PLAIN DISC D 500	GLATTE SCHEIBE D 500	DISCO	
003	130170	001	AXE	PIN	ACHSE	ASSE	
004	130314	002	VIS REGLA.CC MAST.100/120/150	SCREW	SCHRAUBE	VITE	
005	211817	002	BUTEE	STOP	ANSCHLAG	LIMITATORE	
006	432023	002	ENTRETOISE	SPACER	DISTANZHUELSE	DISTANZIALE	
007	581960	001	TIGE	STEM	STANGE	STELO	
008	581961	001	TIGE	STEM	STANGE	STELO	
009	582700	001	BRAS	ARM	ARM	BRACCIO	
010	582701	001	BRAS	ARM	ARM	BRACCIO	
011	645317	002	MOYEU	HUB	NABE	MOZZO	
012	951166	004	BAGUE NADELLA 35/43	SEAL 35/43	RING 35/43	BOCCOLA	
013	80061638	002	VIS TETE HEXAGONALE FE/ZNXC3	HEXAGON HEAD SCREW FE/ZNXC3	SECHSKANTSCHRAUBE FE/ZNXC3	VITE TESTA ESAGONALE FE/ZNXC3	
014	80091640	002	VIS TETE HEX.B.SPHE.FE/ZNXC3	HEXAGON HEAD SCREW FE/ZNXC3	SECHSKANTSCHRAUBE FE/ZNXC3	VITE TESTA ESAGONALE FE/ZNXC3	
015	80111029	012	VIS T.FRAI.SIX P.CR.FLZNNC	HEX.SOC.COUNT.HEAD SC.FLZNNC	SENKSCHRAUB.INNENSEC.FLZNNC	VITE FLZNNC	
016	80201030	012	ECROU HEX.AUTOFREINE FE/ZNXC3	SELF-LOCKING NUT FE/ZNXC3	SELBSTSICH.MUTTER FE/ZNXC3	DADO AUTOBLOCCANTE FE/ZNXC3	
017	80201670	002	ECROU HEXAGONAL FE/ZNXC3	NUT FE/ZNXC3	SECHSKANTMUTTER FE/ZNXC3	DADO FE/ZNXC3	
018	80202030	002	ECROU HEX.AUTOFREINE FE/ZNXC3	SELF-LOCKING NUT FE/ZNXC3	SELBSTSICH.MUTTER FE/ZNXC3	DADO AUTOBLOCCANTE FE/ZNXC3	
019	80202402	002	ECROU HEXAGONAL BAS FE/ZNXC3	NUT FE/ZNXC3	SECHSKANTMUTTER FE/ZNXC3	DADO FE/ZNXC3	
020	80202421	002	ECROU HEXAG.EMBASE AUTOFR.	SELF-LOCKING NUT	SELBSTSICHERNDE MUTTER	DADO AUTOBLOCCANTE	
021	80202566	002	ECROU A ENCOCH.AUTOF.FE/ZNXC3	SELF-LOCKING NUT FE/ZNXC3	SELBSTSICHERN.MUTTER FE/ZNXC3	DADO AUTOBLOCCANTE FE/ZNXC3	
022	80252432	002	RONDELLE PLATE FE/ZNXC3	PLAIN WASHER FE/ZNXC3	SCHEIBE FE/ZNXC3	RONDELLA PIATTA FE/ZNXC3	
023	80271686	002	RONDELLE RESSORT SP.FLZNNC	SPHERICAL SPRING WASH.FLZNNC	FEDERRING FLZNNC	RONDELLA A MOLLA FLZNNC	
024	80440860	002	GOUPILLE SPIRALE	ROLL PIN	SPIRAL-SPANNSTIFTE	SPINA ELASTICA	
025	80595200	002	CIRCLIP INTERIEUR	RETAINING RING	SICHERUNGSRING	ANELLO	
026	81302552	004	ROULEMENT A ROULEAUX CONIQUES	TAPERED ROLLER BEARING	KEGELROLLENLAGER	CUSCINETTO A RULLO	
027	82201016	002	GRAISSEUR AUTOTARAUDANT	SELF TAPPING GREASE NIPPLE	GEWINDESCHNEID-SCHMIERNIPPEL	INGRASSATORE	

Даровые
 (050)-207-68-47
 (050)-407-68-45





COUTRE CIRCULAIRE Ø600 T

DISC COULTER Ø600 T

SCHEIBENSECH Ø600 T

ASSOLCATORE A DISCO Ø600 T

Rep	Nr	Qt	Designation	Description	Bezeichnung	Referenza	Remarque - Remark - Bemerkung - Osservazioni
001	110031	002	DISQUE CC CRENELE DIA600	NOTCHED DISC D 600	GEZACKTE SCHEIBE D 600	DISCO D 600	
002	130170	001	AXE	PIN	ACHSE	ASSE	
003	130314	002	VIS REGLA.CC MAST.100/120/150	SCREW	SCHRAUBE	VITE	
004	211817	002	BUTEE	STOP	ANSCHLAG	LIMITATORE	
005	432023	002	ENTRETOISE	SPACER	DISTANZHUELSE	DISTANZIALE	
006	581962	001	TIGE	STEM	STANGE	STELO	
007	581963	001	TIGE	STEM	STANGE	STELO	
008	582700	001	BRAS	ARM	ARM	BRACCIO	
009	582701	001	BRAS	ARM	ARM	BRACCIO	
010	645317	002	MOYEU	HUB	NABE	MOZZO	
011	951166	004	BAGUE NADELLA 35/43	SEAL 35/43	RING 35/43	BOCCOLA	
012	80061638	002	VIS TETE HEXAGONALE FE/ZNXC3	HEXAGON HEAD SCREW FE/ZNXC3	SECHSKANTSCHRAUBE FE/ZNXC3	VITE TESTA ESAGONALE FE/ZNXC3	
013	80091640	002	VIS TETE HEX.B.SPHE.FE/ZNXC3	HEXAGON HEAD SCREW FE/ZNXC3	SECHSKANTSCHRAUBE FE/ZNXC3	VITE TESTA ESAGONALE FE/ZNXC3	
014	80111029	012	VIS T.FRAI.SIX P.CR.FLZNNC	HEX.SOC.COUNT.HEAD SC.FLZNNC	SENKSCHRAUB.INNENSEC.FLZNNC	VITE FLZNNC	
015	80201030	012	ECROU HEX.AUTOFREINE FE/ZNXC3	SELF-LOCKING NUT FE/ZNXC3	SELBSTSICH.MUTTER FE/ZNXC3	DADO AUTOBLOCCANTE FE/ZNXC3	
016	80201670	002	ECROU HEXAGONAL FE/ZNXC3	NUT FE/ZNXC3	SECHSKANTMUTTER FE/ZNXC3	DADO FE/ZNXC3	
017	80202030	002	ECROU HEX.AUTOFREINE FE/ZNXC3	SELF-LOCKING NUT FE/ZNXC3	SELBSTSICH.MUTTER FE/ZNXC3	DADO AUTOBLOCCANTE FE/ZNXC3	
018	80202402	002	ECROU HEXAGONAL BAS FE/ZNXC3	NUT FE/ZNXC3	SECHSKANTMUTTER FE/ZNXC3	DADO FE/ZNXC3	
019	80202421	002	ECROU HEXAG.EMBASE AUTOFR.	SELF-LOCKING NUT	SELBSTSICHERNDE MUTTER	DADO AUTOBLOCCANTE	
020	80202566	002	ECROU A ENCOCH.AUTOF.FE/ZNXC3	SELF-LOCKING NUT FE/ZNXC3	SELBSTSICHERN.MUTTER FE/ZNXC3	DADO AUTOBLOCCANTE FE/ZNXC3	
021	80252432	002	RONDELLE PLATE FE/ZNXC3	PLAIN WASHER FE/ZNXC3	SCHEIBE FE/ZNXC3	RONDELLA PIATTA FE/ZNXC3	
022	80271686	002	RONDELLE RESSORT SP.FLZNNC	SPHERICAL SPRING WASH.FLZNNC	FEDERRING FLZNNC	RONDELLA A MOLLA FLZNNC	
023	80440860	002	GOUPILLE SPIRALE	ROLL PIN	SPIRAL-SPANNSTIFTE	SPINA ELASTICA	
024	80595200	002	CIRCLIP INTERIEUR	RETAINING RING	SICHERUNGSRING	ANELLO	
025	81302552	004	ROULEMENT A ROULEAUX CONIQUES	TAPERED ROLLER BEARING	KEGELROLLENLAGER	CUSCINETTO A RULLO	
026	82201016	002	GRAISSEUR AUTOTARAUDANT	SELF TAPPING GREASE NIPPLE	GEWINDESCHNEID-SCHMIERNIPPEL	INGRASSATORE	

Автомобильные запчасти
 (050)-407-68-47
 (050)-407-68-45

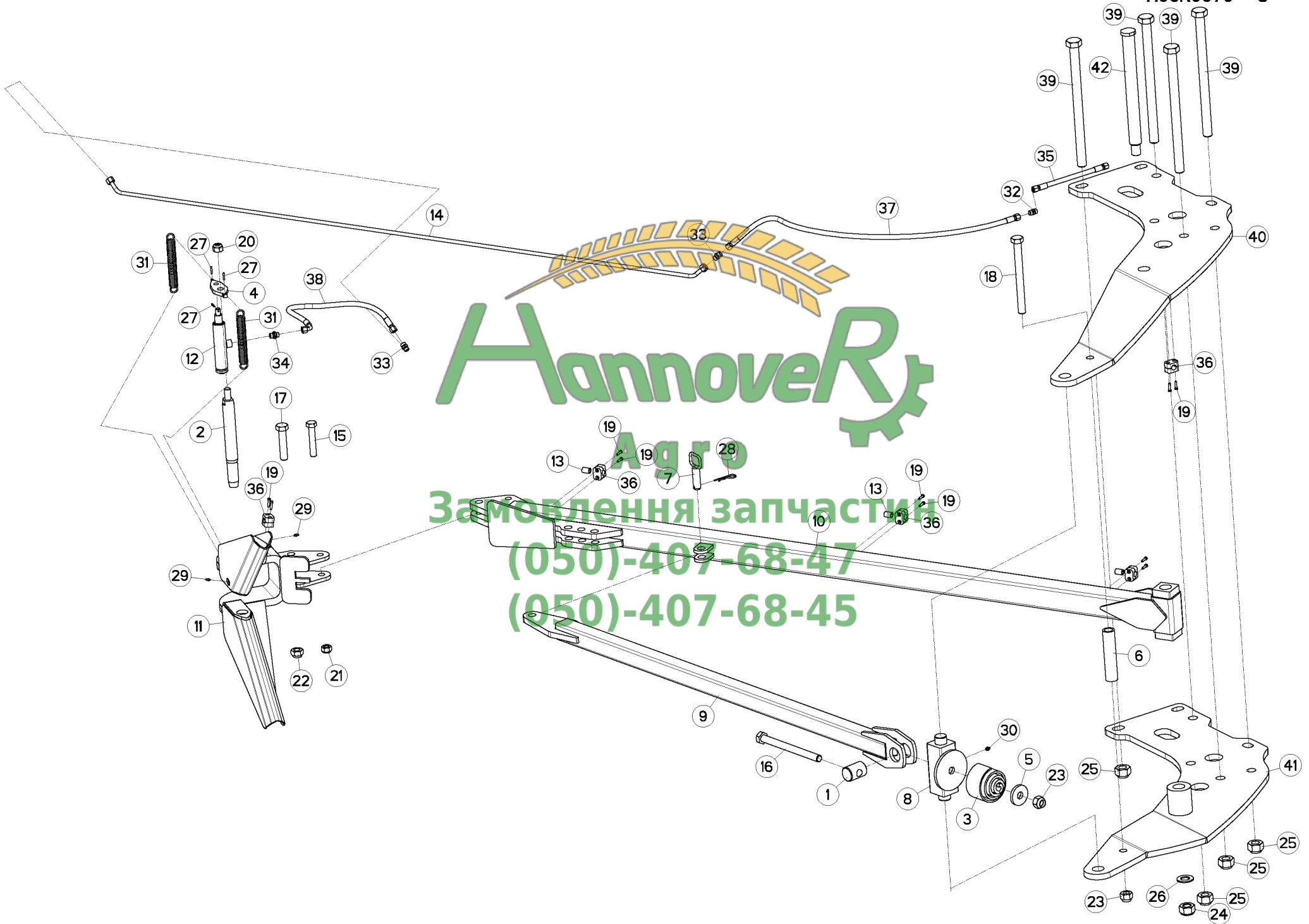



BRAS OUTIL TRAINÉ MLD

FURROW PRESS ARM MLD

PACKERARM MLD

SOTTOCOMPRESSORE BRACCIO M

Rep	Nr	Qt	Designation	Description	Bezeichnung	Referenza	Remarque - Remark - Bemerkung - Osservazioni
001	130342	001	AXE TIRANT	AXE TIRANT	ACHSE	ASSE	
002	131036	001	DOIGT	FINGER	FINGER	DENTE	
003	194106	001	RESSORT VOLUTE REF:G 25	SPRING	FEDER	MOLLA	
004	211228	001	PLAQUE	PLATE	PLATTE	PIASTRA	
005	445475	001	RONDELLE RESSORT	WASHER	SCHEIBE	RONDELLA	
006	445476	001	ENTRETOISE	SPACER	DISTANZHUELSE	DISTANZIALE	
007	582262	001	AXE AMOVIBLE	PIN	ACHSE	PERNO	
008	582538	001	SUPPORT	SUPPORT	TRAEGER	SUPPORTO	
009	582539	001	TIRANT	TIE ROD	ZUGSTANGE	TIRANTE	
010	583707	001	BRAS	ARM	ARM	BRACCIO	
011	583710	001	ANCRE B.O.T.	MOUNTING	FANGHAKEN	GANCIO	
012	951184	001	VERIN B.O.T.	CYLINDER	ZYLINDER KOMPLET VORN	MARTINETTO	
013	951197	003	GAINE CAOUTCHOUC	SHEATHE	HUELLE	GUAINA CAOUTCHOUC	
014	951430	001	TUYAU	PIPE	ROHR	TUBO	
015	80062080	001	VIS TETE HEXAGONALE FE/ZNXC3	HEXAGON HEAD SCREW FE/ZNXC3	SECHSKANTSCHRAUBE FE/ZNXC3	VITE TESTA ESAGONALE FE/ZNXC3	
016	80062479	001	VIS TETE HEXAGONALE FE/ZNXC3	HEXAGON HEAD SCREW FE/ZNXC3	SECHSKANTSCHRAUBE FE/ZNXC3	VITE TESTA ESAGONALE FE/ZNXC3	
017	80062487	001	VIS TETE HEXAGONALE FE/ZNXC3	HEXAGON HEAD SCREW FE/ZNXC3	SECHSKANTSCHRAUBE FE/ZNXC3	VITE TESTA ESAGONALE FE/ZNXC3	
018	80062498	001	VIS TETE HEXAGONALE FE/ZNXC3	HEXAGON HEAD SCREW FE/ZNXC3	SECHSKANTSCHRAUBE FE/ZNXC3	VITE TESTA ESAGONALE FE/ZNXC3	
019	80080626	010	VIS TETE CYL.SIX P.CR.FE/ZNXC3	SCREW, SOCKET HEAD FE/ZNXC3	ZYLINDERSCHR.INNENSEC.FE/ZNXC3	VITE A TESTA CILINDR. FE/ZNXC3	
020	80202030	001	ECROU HEX.AUTOFREINE FE/ZNXC3	SELF-LOCKING NUT FE/ZNXC3	SELBSTSICH.MUTTER FE/ZNXC3	DADO AUTOBLOCCANTE FE/ZNXC3	
021	80202040	001	ECROU HEX.BAS AUTOFR.FE/ZNXC3	SELF-LOCKING NUT FE/ZNXC3	SELBSTSICHERND.MUTTER FE/ZNXC3	DADO AUTOBLOCCANTE FE/ZNXC3	
022	80202442	001	ECROU HEX.BAS AUTOFR.FE/ZNXC3	SELF-LOCKING NUT FE/ZNXC3	SELBSTSICHERND.MUTTER FE/ZNXC3	DADO AUTOBLOCCANTE FE/ZNXC3	
023	80202447	002	ECROU HEXA.AUTOFREINE FE/ZNXC3	SELF-LOCKING NUT FE/ZNXC3	SELBSTSICHERNDE MUTT.FE/ZNXC3	DADO AUTOBLOCCANTE FE/ZNXC3	
024	80203030	001	ECROU HEX.BAS AUTOFR.FE/ZNXC3	SELF-LOCKING NUT FE/ZNXC3	SELBSTSICHERND.MUTTER FE/ZNXC3	DADO AUTOBLOCCANTE FE/ZNXC3	
025	80203047	004	ECROU HEXAGONAL AUTOFREINE	SELF-LOCKING NUT	SELBSTSICHERNDE MUTTER	DADO AUTOBLOCCANTE	
026	80253034	001	RONDELLE PLATE FE/ZNXC3	PLAIN WASHER FE/ZNXC3	SCHEIBE FE/ZNXC3	RONDELLA PIATTA FE/ZNXC3	
027	80450499	003	GOUPILLE ELASTIQUE INOX	ROLL PIN INOX	SPANNHUELSE INOX	SPINA ELASTICA INOX	
028	80570477	001	GOUPILLE BETA SIMPLE FE/ZNXC3	SPRING COTTER PIN FE/ZNXC3	FEDERSTECKER FE/ZNXC3	MOLLARE FE/ZNXC3	
029	82200616	002	GRAISSEUR AUTOTAR.FE/ZNXC3	TAPPING GREASE NIPPLE FE/ZNXC3	GEWINDESCH.SCHMIERNIP.FE/ZNXC3	INGRASSATORE FE/ZNXC3	
030	82201016	001	GRAISSEUR AUTOTARAUDANT	SELF TAPPING GREASE NIPPLE	GEWINDESCHNEID-SCHMIERNIPPEL	INGRASSATORE	
031	951185	002	RESSORT	SPRING	FEDER	MOLLA	
032	A4080300	001	UNION DOUBLE FE/ZNXC3	STRAIGHT COUPLING FE/ZNXC3	GERADE VERSCHRAUBUNG FE/ZNXC3	GIUNZIONE DIRITTA FE/ZNXC3	
033	A4080350	002	UNION DOUBLE NUE ZBC	STRAIGHT COUPLING ZBC	GERADE VERSCHRAUBUNG ZBC	GIUNZIONE DIRITTA ZBC	
034	A4080401	001	UNION MALE	MALE STUD CONNECTOR	GERADER EINSCHRAUBSTUTZEN	GIUZIONE DIRITTA ZBC	
035	A4921014	001	FLEXIBLE HYDRAULIQUE	HYDRAULIC HOSE	HYDRAULIKSCHLAUCH	TUBO GOMMA	<->300 mm
036	A7260027	005	COLLIER SIMPLE D18 NU	CLAMP D.18	SCHELLE D.18	COLLARE D.18	
037	A4921054	001	FLEXIBLE HYDRAULIQUE	HYDRAULIC HOSE	HYDRAULIKSCHLAUCH	TUBO GOMMA	<->5500 mm
038	A4921066	001	FLEXIBLE HYDRAULIQUE	HYDRAULIC HOSE	HYDRAULIKSCHLAUCH	TUBO GOMMA	<->600 mm
039	H0205110	004	VIS TETE HEXAGONALE	SCREW, HEX HEAD	SECHSKANTSCHRAUBE	VITE A TESTA ESAGONALE	
040	H0602340	001	SUPPORT	SUPPORT	TRAEGER	SUPPORTO	
041	H0602350	001	SUPPORT	SUPPORT	TRAEGER	SUPPORTO	
042	H0602360	001	AXE	PIN	ACHSE	ASSE	

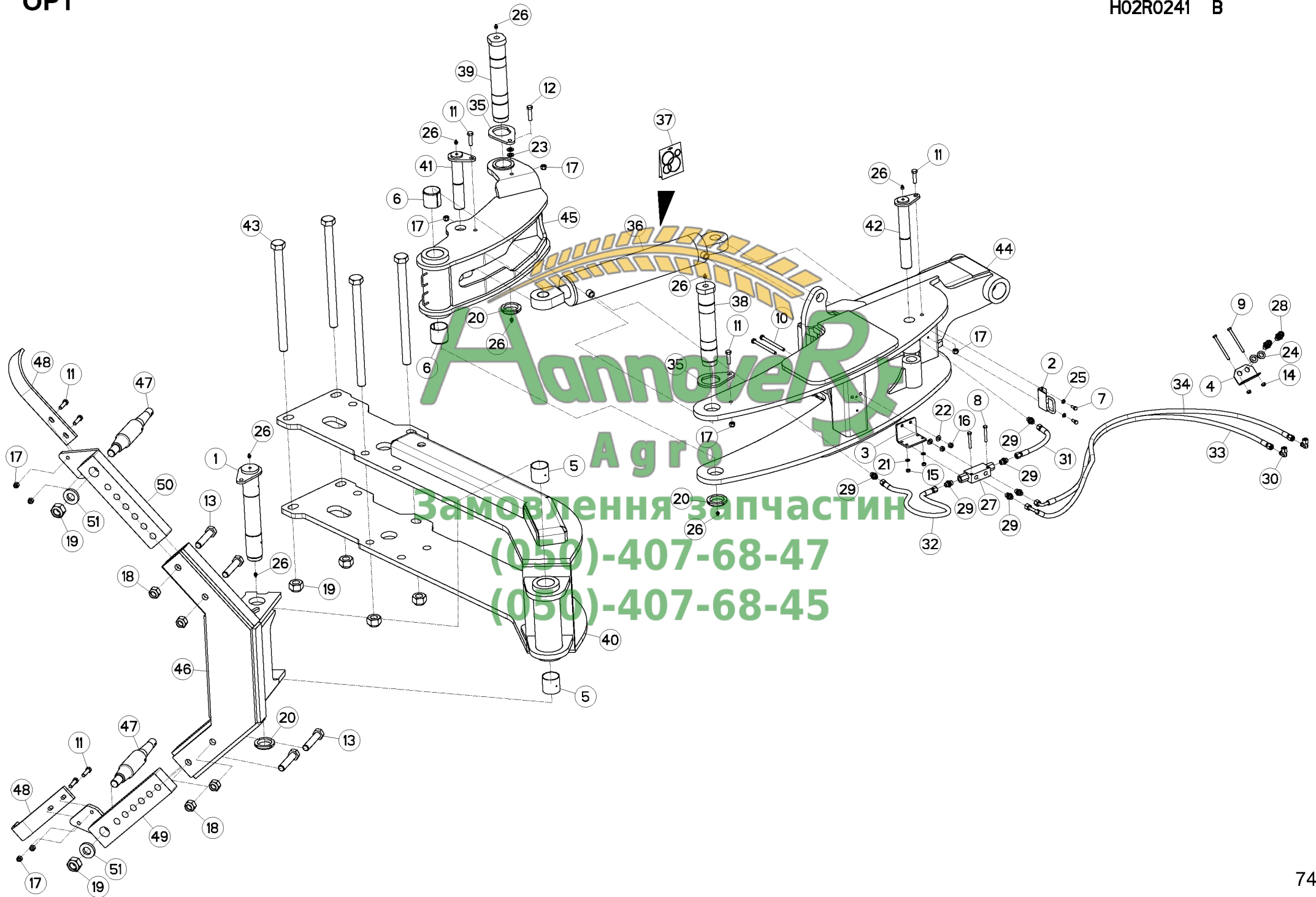



SUPPORT ON-LAND

SUPPORT ON-LAND

HALTERUNG ON-LAND

SUPPORTO ON-LAND

Rep	Nr	Qt	Designation	Description	Bezeichnung	Referenza	Remarque - Remark - Bemerkung - Osservazioni
001	582519	001	AXE	PIN	ACHSE	ASSE	
002	582742	001	EQUERRE	GUSSET, CORNER	WINKEL	SQUADRA	
003	780113	001	PATTE DE FIXATION	PLATE	SCHLAUCHHALTER	PIASTRINA	
004	780340	001	EQUERRE	GUSSET, CORNER	WINKEL	SQUADRA	
005	951448	002	BAGUE ROULEE	WRAPPED BUSH	GEROLLTE BUCHSE MESSING	ANELLO LUBRIFICATO	
006	951521	002	BAGUE ELASTIQUE	TENSION BUSH	EINSPANNBUECHSE	SPINA ELASTICA	
007	80060820	002	VIS TETE HEXAGONALE FE/ZNXC3	HEXAGON HEAD SCREW FE/ZNXC3	SECHSKANTSCHRAUBE FE/ZNXC3	VITE TESTA ESAGONALE FE/ZNXC3	
008	80060853	002	VIS TETE HEXAGONALE FE/ZNXC3	HEXAGON HEAD SCREW FE/ZNXC3	SECHSKANTSCHRAUBE FE/ZNXC3	VITE TESTA ESAGONALE FE/ZNXC3	
009	80060864	002	VIS TETE HEXAGONALE FE/ZNXC3	HEXAGON HEAD SCREW FE/ZNXC3	SECHSKANTSCHRAUBE FE/ZNXC3	VITE TESTA ESAGONALE FE/ZNXC3	
010	80061066	002	VIS TETE HEXAGONALE FE/ZNXC3	HEXAGON HEAD SCREW FE/ZNXC3	SECHSKANTSCHRAUBE FE/ZNXC3	VITE TESTA ESAGONALE FE/ZNXC3	
011	80061245	007	VIS TETE HEXAGONALE FE/ZNXC3	HEXAGON HEAD SCREW FE/ZNXC3	SECHSKANTSCHRAUBE FE/ZNXC3	VITE TESTA ESAGONALE FE/ZNXC3	
012	80061249	001	VIS TETE HEXAGONALE FE/ZNXC3	HEXAGON HEAD SCREW FE/ZNXC3	SECHSKANTSCHRAUBE FE/ZNXC3	VITE TESTA ESAGONALE FE/ZNXC3	
013	80062483	004	VIS TETE HEXAGONALE FLZNNC	HEXAGON HEAD SCREW FLZNNC	SECHSKANTSCHRAUBE FLZNNC	VITE TESTA ESAGONALE FLZNNC	
014	80200830	002	ECROU HEX.AUTOFREINE FE/ZNXC3	SELF-LOCKING NUT FE/ZNXC3	SELBSTSICHERNDE MUTT.FE/ZNXC3	DADO AUTOBLOCCANTE FE/ZNXC3	
015	80200840	002	ECROU HEX.BAS AUTOFR.FE/ZNXC3	SELF-LOCKING NUT FE/ZNXC3	SELBSTSICHERNDE MUTTER FE/ZNXC3	DADO AUTOBLOCCANTE FE/ZNXC3	
016	80201030	002	ECROU HEX.AUTOFREINE FE/ZNXC3	SELF-LOCKING NUT FE/ZNXC3	SELBSTSICH.MUTTER FE/ZNXC3	DADO AUTOBLOCCANTE FE/ZNXC3	
017	80201230	008	ECROU HEX.AUTOFREINE FE/ZNXC3	SELF-LOCKING NUT FE/ZNXC3	SELBSTSICH.MUTTER FE/ZNXC3	DADO AUTOBLOCCANTE FE/ZNXC3	
018	80202447	004	ECROU HEXA.AUTOFREINE FE/ZNXC3	SELF-LOCKING NUT FE/ZNXC3	SELBSTSICHERNDE MUTT.FE/ZNXC3	DADO AUTOBLOCCANTE FE/ZNXC3	
019	80203047	006	ECROU HEXAGONAL AUTOFREINE	SELF-LOCKING NUT	SELBSTSICHERNDE MUTTER	DADO AUTOBLOCCANTE	
020	80205566	003	ECROU A ENCOCH.AUTOF.FE/ZNXC3	SELF-LOCKING NUT FE/ZNXC3	SELBSTSICHERN.MUTTER FE/ZNXC3	DADO AUTOBLOCCANTE FE/ZNXC3	
021	80250823	002	RONDELLE PLATE FE/ZNXC3	PLAIN WASHER FE/ZNXC3	SCHEIBE FE/ZNXC3	RONDELLA PIATTA FE/ZNXC3	
022	80251021	002	RONDELLE PLATE FE/ZNXC3	PLAIN WASHER FE/ZNXC3	SCHEIBE FE/ZNXC3	RONDELLA PIATTA FE/ZNXC3	
023	80251227	002	RONDELLE PLATE FE/ZNXC3	PLAIN WASHER FE/ZNXC3	SCHEIBE FE/ZNXC3	RONDELLA PIATTA FE/ZNXC3	
024	80251624	002	RONDELLE PLATE FE/ZNXC3	PLAIN WASHER FE/ZNXC3	SCHEIBE FE/ZNXC3	RONDELLA PIATTA FE/ZNXC3	
025	80270803	002	RONDELLE GROWER FE/ZNXC3	SPRING LOCK WASHER FE/ZNXC3	FEDERRING FE/ZNXC3	RONDELLA GROWER FE/ZNXC3	
026	82201016	008	GRAISSEUR AUTOTARAUDANT	SELF TAPPING GREASE NIPPLE	GEWINDESCHNEID-SCHMIERNIPPEL	INGRASSATORE	
027	A4071228	001	CLAPET	VALVE, FLAP	RUECKSCHLAGVENTIL	VALVOLA	
028	A4080302	002	UNION DOUBLE / CLOISON	BULKHEAD UNION	VERBINDUNGSNIPPEL	CONNETTORE	
029	A4080401	006	UNION MALE	MALE STUD CONNECTOR	GERADER EINSCHRAUBSTUTZEN	GIUZIONE DIRITTA ZBC	
030	A4082700	002	COUDE TOURNANT	AJUSTABLE MALE STUD ELBOW	EINSTELLBARER WINKELSTUTZEN	GIUNZIONE A 90°ORIENTABILE	
031	A4921014	001	FLEXIBLE HYDRAULIQUE	HYDRAULIC HOSE	HYDRAULIKSCHLAUCH	TUBO GOMMA	<->300 mm
032	A4921014	001	FLEXIBLE HYDRAULIQUE	HYDRAULIC HOSE	HYDRAULIKSCHLAUCH	TUBO GOMMA	<->300 mm
033	A4921076	001	FLEXIBLE HYDRAULIQUE	HYDRAULIC HOSE	HYDRAULIKSCHLAUCH	TUBO GOMMA	<->1550 mm
034	A4921076	001	FLEXIBLE HYDRAULIQUE	HYDRAULIC HOSE	HYDRAULIKSCHLAUCH	TUBO GOMMA	<->1550 mm
035	H0100350	002	PLAQUETTE ARRETOIR	STOP PLATE	ARRETIERUNGSBLECH	PLACHETTA	
036	H0103020	001	VERIN	CYLINDER, HYDRAULIC	HYDRAULIKZYLINDER	CILINDRO	
037	H0103030	001	POCHETTE	KIT, SEAL	TACHE	SACCHE	: H0103020
038	H0104010	001	AXE	PIN	ACHSE	ASSE	
039	H0105120	001	AXE	PIN	ACHSE	ASSE	
040	H0205010	001	SUPPORT	SUPPORT	TRAEGER	SUPPORTO	
041	H0205090	001	AXE	PIN	ACHSE	ASSE	
042	H0205100	001	AXE	PIN	ACHSE	ASSE	
043	H0205110	004	VIS TETE HEXAGONALE	SCREW, HEX HEAD	SECHSKANTSCHRAUBE	VITE A TESTA ESAGONALE	
044	H0207360	001	BOITIER	HOUSING	GEHAEUSE	SCATOLA	
045	H0208220	001	BIELLE	LINK, CONNECTING	LENKER	BIELLA	
046	H0601170	001	SUPPORT	SUPPORT	TRAEGER	SUPPORTO	
047	H0601180	002	AXE	PIN	ACHSE	ASSE	
048	H0601190	002	DECROTTOIR	SCRAPER, DIRT	ABSTREIFER	RASCHIATORE	

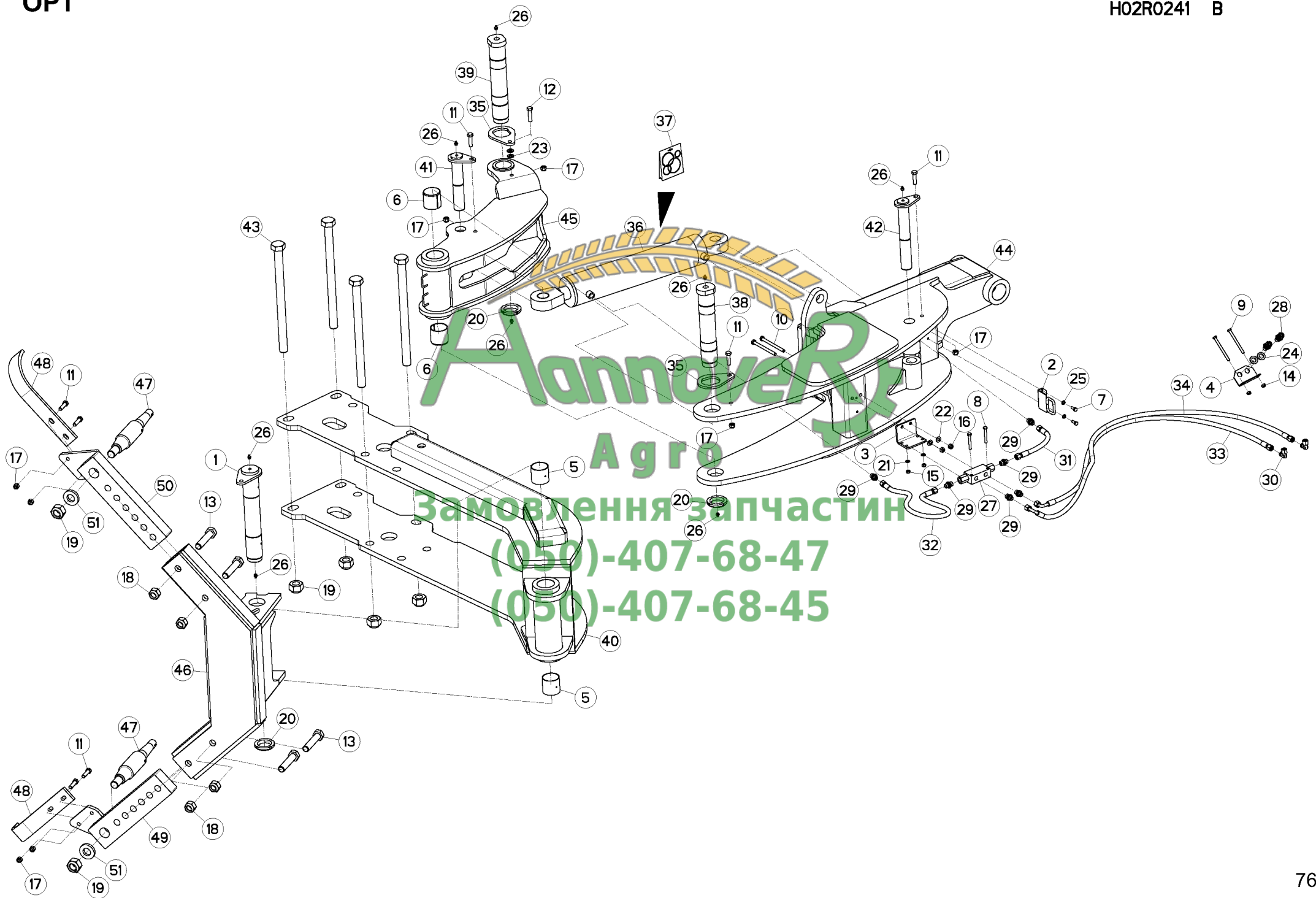



MULTI-LEADER T

C0000 >

H02R0241 B

SUPPORT ON-LAND

SUPPORT ON-LAND

HALTERUNG ON-LAND

SUPPORTO ON-LAND

Rep	Nr	Qt	Designation	Description	Bezeichnung	Referenza	Remarque - Remark - Bemerkung - Osservazioni
049	H0601200	001	BRAS	ARM	ARM	BRACCIO	
050	H0601210	001	BRAS	ARM	ARM	BRACCIO	
051	H0601220	002	RONDELLE	WASHER	SCHEIBE	RONDELLA PIATTA	



Замовлення запчастин

(050)-407-68-47

(050)-407-68-45

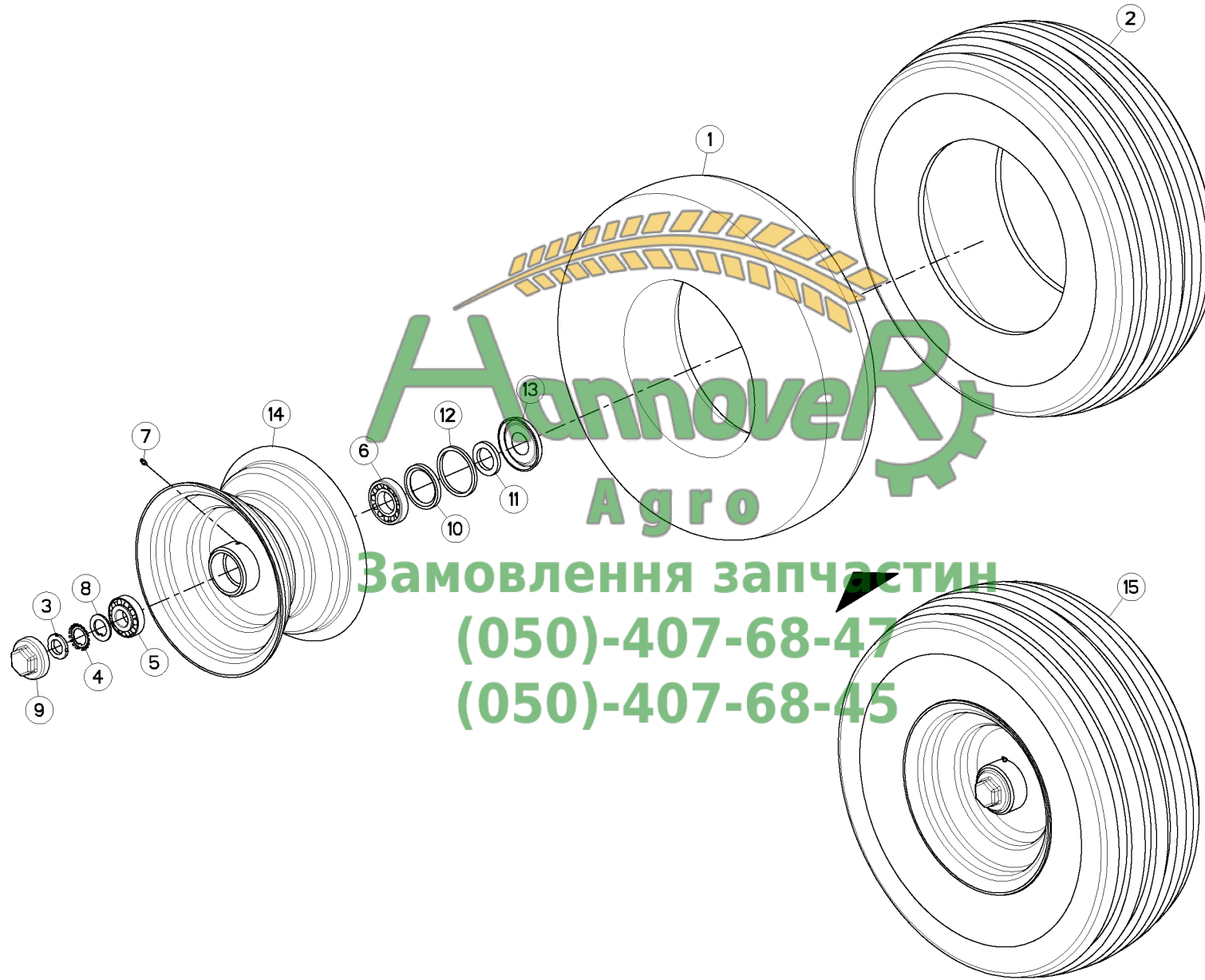



MULTI-LEADER T

C0000 >

H05R0077 A

ROUE DE PROFONDEUR Ø690X250

DEPTH WHEEL Ø690X250

TASTRAD Ø690X250

RUOTA DI PROFONDITA' Ø690X250

Rep	Nr	Qt	Designation	Description	Bezeichnung	Referenza	Remarque - Remark - Bemerkung - Osservazioni
001	900155	001	CHAMBRE A AIR ROUE 569124	INNER TUBE WHEEL 569124	SCHLAUCH	CAMERA	
002	900156	001	PNEU 446 10./75-12 10PR	TYRE WHEEL 446 10./75-12 10PR	REIFEN 446 10./75-12 10PR	PNEUMATICO 446 10./75-12 10PR	
003	80203018	001	ECROU A ENCOCHES	SLOTTED ROUND NUT	NUTMUTTER	DADO	
004	80293020	001	RONDELLE-FREIN	TAB WASHER	SICHERUNGSBLECH	RONDELLA-FRENO	
005	81303072	001	ROULEMENT A ROULEAUX CONIQUES	TAPERED ROLLER BEARING	KEGELROLLENLAGER	CUSCINETTO A RULLO	
006	81304079	001	ROULEMENT A ROULEAUX CONIQUES	TAPERED ROLLER BEARING	KEGELROLLENLAGER	CUSCINETTO A RULLO	
007	82200600	001	GRAISSEUR FE/ZNXC3	GREASE NIPPLE FE/ZNXC3	SCHMIERNIPPEL FE/ZNXC3	INGRASSATORE FE/ZNXC3	
008	H0500480	001	RONDELLE FREIN	WASHER	SCHEIBE	RONDELLA	
009	H0500490	001	CHAPEAU A VISSER	CAP	KAPPE	COPERCHIO	
010	H0500500	001	JOINT LEVRE 60X80X8	SEAL	DICHTUNG	GUARNIZIONE	
011	H0500510	001	RONDELLE	WASHER	SCHEIBE	RONDELLA PIATTA	
012	H0500520	001	BAGUE FEUTRE	BUSH	HUELSE	BOCCOLA	
013	H0500530	001	CHAPEAU D'ETANCHEITE	CAP	KAPPE	COPERCHIO	
014	H0500580	001	JANTE ROUE 7.00 X 12 X 4.0	RIM	FELGE	CERCHIO	
015	H0500590	001	ROUE	WHEEL AND TIRE ASSEMBLY	RAD	RUOTA	



Замовлення запчастин

(050)-407-68-47

(050)-407-68-45



Замовлення запчастин
(050)-407-68-47
(050)-407-68-45



SELECTEUR ELECTROHYDR.4 FONC. ELECTROHYDR.SELECTOR 4 FUNCT. ELECTROHYDR.SELECTOR 4 FUNKT. ELECTROIDRA.SELETTORE 4 FUNZ.

Rep	Nr	Qt	Designation	Description	Bezeichnung	Referenza	Remarque - Remark - Bemerkung - Osservazioni
001	750753	001	SUPPORT ELECTRODISTRIBUTEUR	BRACKET	HALTERUNG	SUPPORTO	
002	80060826	004	VIS TETE HEXAGONALE FE/ZNXC3	HEXAGON HEAD SCREW FE/ZNXC3	SECHSKANTSCHRAUBE FE/ZNXC3	VITE TESTA ESAGONALE FE/ZNXC3	
003	80060834	002	VIS TETE HEXAGONALE FE/ZNXC3	HEXAGON HEAD SCREW FE/ZNXC3	SECHSKANTSCHRAUBE FE/ZNXC3	VITE TESTA ESAGONALE FE/ZNXC3	
004	80080530	004	VIS TETE CYL.SIX P.CR.FE/ZNXC3	HEX.SOCK.HEAD CAP SCR.FE/ZNXC3	ZYLINDERSCHR.INNENSEC.FE/ZNXC3	VITE A TESTA CILINDR. FE/ZNXC3	
005	80080555	004	VIS TETE CYL.SIX P.CREUX	HEX.SOCKET HEAD CAP SCREW	ZYLINDERSCHR.INNENSECHSK	VITE	
006	80080570	008	VIS TETE CYL.SIX P.CR.FE/ZNXC3	HEX.SOCK.HEAD CAP SCR.FE/ZNXC3	ZYLINDERSCHR.INNENSEC.FE/ZNXC3	VITE A TESTA CILINDR. FE/ZNXC3	
007	80200830	002	ECROU HEX.AUTOFREINE FE/ZNXC3	SELF-LOCKING NUT FE/ZNXC3	SELBSTSICHERNDE MUTT.FE/ZNXC3	DADO AUTOBLOCCANTE FE/ZNXC3	
008	80250823	002	RONDELLE PLATE FE/ZNXC3	PLAIN WASHER FE/ZNXC3	SCHEIBE FE/ZNXC3	RONDELLA PIATTA FE/ZNXC3	
009	80270803	004	RONDELLE GROWER FE/ZNXC3	SPRING LOCK WASHER FE/ZNXC3	FEDERRING FE/ZNXC3	RONDELLA GROWER FE/ZNXC3	
010	A4050003	003	DISTRIBUTEUR CETOP3				
011	A4050005	001	DISTRIBUTEUR CETOP3				
012	A4061504	002	OBTURATEUR ZBC	BLANKING PLUG ZBC	VERSCHLUSSSTOPFEN ZBC	TAPPO FEMMINA ZBC	: sillon
012	A4061501	002	OBTURATEUR ZBC	BLANKING PLUG ZBC	VERSCHLUSSSTOPFEN ZBC	TAPPO FEMMINA ZBC	: on land
013	A4061802	001	BOUCHON 3/8G CHC F.E FE/ZNXC3	PLUG 3/8G CHC F.E FE/ZNXC3	VERSCHLUSSSCHRAUBE 3/8G CHC F.	TAPPO 3/8G CHC F.E FE/ZNXC3	
014	A4061803	002	BOUCHON	PLUG	VERSCHLUSSSCHRAUBE	TAPPO	
015	A4071207	004	CLAPET	VALVE, FLAP	RUECKSCHLAGVENTIL	VALVOLA	
016	A4074018	002	COUPLEUR MALE	CONNECTOR MALE	KUPPLUNGSTECKER	ATTACCO IDRAULICO	
017	82300026	002	CAPUCHON COUPLEUR MALE	CAP MALE CONNECTOR	KAPPE KUPPLUNGSSTECKER	TAPPO	
018	A4080401	004	UNION MALE	MALE STUD CONNECTOR	GERADER EINSCHRAUBSTUTZEN	GIUZIONE DIRITTA ZBC	: sillon Q? =2 on land
018	A4080429	002	UNION MALE	MALE STUD CONNECTOR	GERADER EINSCHRAUBSTUTZEN	GIUZIONE DIRITTA ZBC	: on land
019	A4080402	002	UNION MALE	MALE STUD CONNECTOR	GERADER EINSCHRAUBSTUTZEN	GIUZIONE DIRITTA ZBC	
020	A4080429	003	UNION MALE	MALE STUD CONNECTOR	GERADER EINSCHRAUBSTUTZEN	GIUZIONE DIRITTA ZBC	
021	A4083100	002	TE ADAPTABLE RENVERSE FE/ZNXC3	ADJ.MALE STUD TEE-STU.FE/ZNXC3	EINSTELLB.T-VERSCHRAU.FE/ZNXC3	TERMINALE A T ORIENTA.FE/ZNXC3	: sillon
021	A4083102	002	TE ADAPTABLE RENVERSE FE/ZNXC3	ADJ.MALE STUD TEE-STU.FE/ZNXC3	EINSTELLB.T-VERSCHRAU.FE/ZNXC3	TERMINALE A T ORIENTA.FE/ZNXC3	: on land
022	A4101036	002	EMBASE	BASE	GRUNDPLATTE	BASE	
023	A4921110	002	FLEXIBLE HYDRAULIQUE	HYDRAULIC HOSE	HYDRAULIKSCHLAUCH	TUBO GOMMA	<->2700 mm : sillon
023	A4923014	002	FLEXIBLE HYDRAULIQUE	HYDRAULIC HOSE	HYDRAULIKSCHLAUCH	TUBO GOMMA	<->0975 mm : on land
024	A4921115	002	FLEXIBLE HYDRAULIQUE	HYDRAULIC HOSE	HYDRAULIKSCHLAUCH	TUBO GOMMA	<->1600 mm : varibar/raidis
024	A4921110	002	FLEXIBLE HYDRAULIQUE	HYDRAULIC HOSE	HYDRAULIKSCHLAUCH	TUBO GOMMA	<->2700 mm : BOT
025	A4923031	002	FLEXIBLE HYDRAULIQUE	HYDRAULIC HOSE	HYDRAULIKSCHLAUCH	TUBO GOMMA	<->950 mm : sillon
025	A4923036	002	FLEXIBLE HYDRAULIQUE	HYDRAULIC HOSE	HYDRAULIKSCHLAUCH	TUBO GOMMA	<->3200 mm : on land
026	A4923035	001	FLEXIBLE HYDRAULIQUE	HYDRAULIC HOSE	HYDRAULIKSCHLAUCH	TUBO GOMMA	<->2800 mm
027	A4923035	001	FLEXIBLE HYDRAULIQUE	HYDRAULIC HOSE	HYDRAULIKSCHLAUCH	TUBO GOMMA	<->2800 mm
028	H0600100	001	FAISCEAU ELECTRIQUE 4,00M	ELECTRIC CABLE	KABELBAUM	FASCIO ELETTRICO	
029	H0500740	001	SELECTEUR ELECTROHYDR. 4 FONC.	ELECTROHYDR. SELECTOR 4 FUNCT.	ELECTROHYDR. SELECTOR 4 FUNKT.	ELECTROIDRA. SELETTORE 4 FUNZ.	
030	H0600090	001	POIGNEE DE CDE ERGOKIT.4 INV.	JOYSTICK	STEUERKNUEPPEL	BARRA DI COMMANDO	

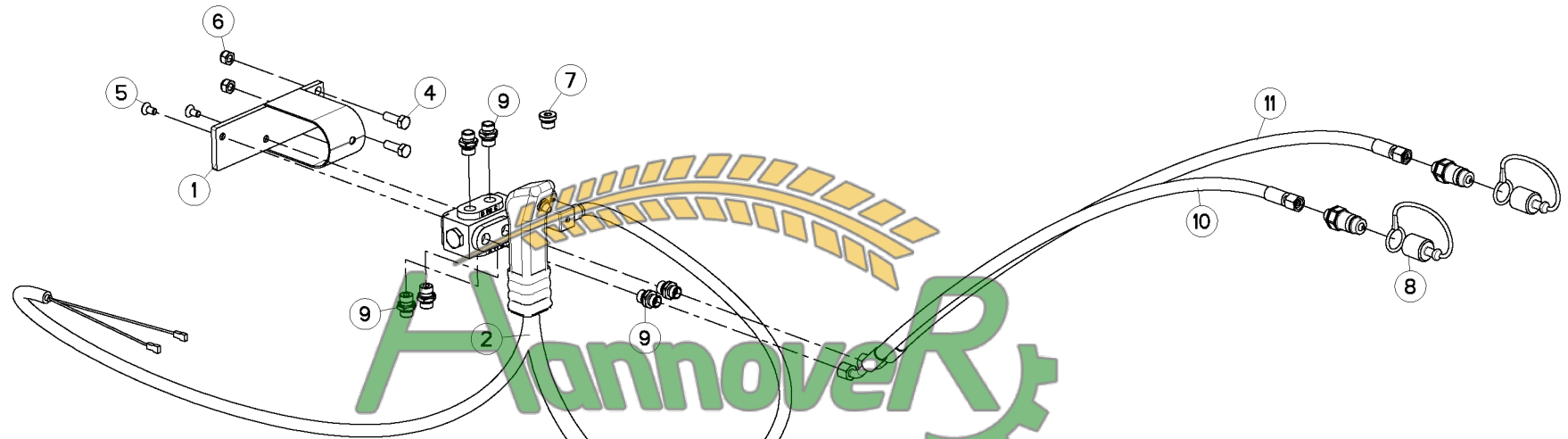

Замовлення запчастин
(050)-407-68-47
(050)-407-68-45

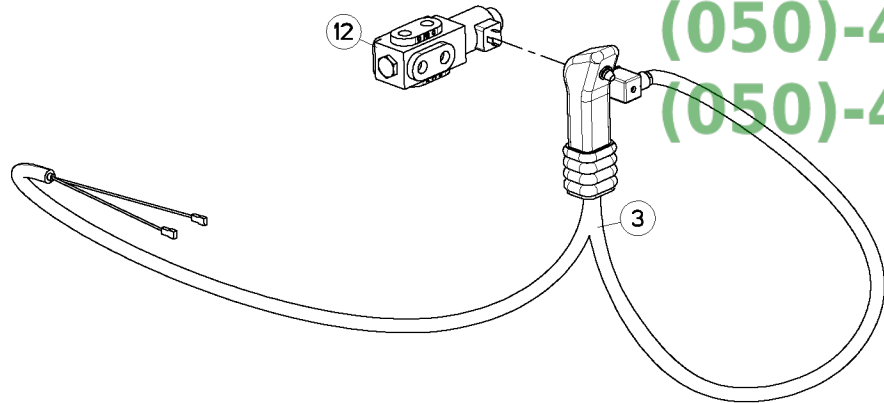



ELECTROVANNE

ELEKTROSWITCH

ELEKTROWAHLSCHALTUNG

ELETTROINTERRUTTORE

Rep	Nr	Qt	Designation	Description	Bezeichnung	Referenza	Remarque - Remark - Bemerkung - Osservazioni
001	582548	001	SUPPORT	SUPPORT	TRAEGER	SUPPORTO	
002	951637	001	SELECTEUR + POIGNEE	SELECTOR + HANDEL	WAHLSCHALTVENTIL + HANGRIFF	SELETTORE + MANIGLIA	
003	952251	001	POIGNEE+CABLE SELECTEUR 951637	HANDEL	HANGRIFF	MANIGLIA	
004	80061036	002	VIS TETE HEXAGONALE FE/ZNXC3	HEXAGON HEAD SCREW FE/ZNXC3	SECHSKANTSCHRAUBE FE/ZNXC3	VITE TESTA ESAGONALE FE/ZNXC3	
005	80110806	002	VIS T.FRAI.SIX P.CR.FE/ZNXC3	HEX.SOC.COUNT.HEAD SC.FE/ZNXC3	SEKSKSCHRAUB INNENSEC FE/ZNXC3	VITE FE/ZNXC3	
006	80201030	002	ECROU HEX.AUTOFREINE FE/ZNXC3	SELF-LOCKING NUT FE/ZNXC3	SELBSTSICH.MUTTER FE/ZNXC3	DADO AUTOBLOCCANTE FE/ZNXC3	
007	A4061802	001	BOUCHON 3/8G CHC F.E FE/ZNXC3	PLUG 3/8G CHC F.E FE/ZNXC3	VERSCHLUSSSCHRAUBE 3/8G CHC F.	TAPPO 3/8G CHC F.E FE/ZNXC3	
008	82300026	002	CAPUCHON COUPLEUR MALE	CAP MALE CONNECTOR	KAPPE KUPPLUNGSSTECKER	TAPPO	
009	A4080401	006	UNION MALE	MALE STUD CONNECTOR	GERADER EINSCHRAUBSTUTZEN	GIUZIONE DIRITTA ZBC	
010	A4921076	001	FLEXIBLE HYDRAULIQUE	HYDRAULIC HOSE	HYDRAULIKSCHLAUCH	TUBO GOMMA	<->1550 mm
011	A4921076	001	FLEXIBLE HYDRAULIQUE	HYDRAULIC HOSE	HYDRAULIKSCHLAUCH	TUBO GOMMA	<->1550 mm
012	H0601070	001	ELECTROVANNE	ELECTRIC SHUT-OFF SLIDE	ELEKTROSCHIEBER	ELETTROVALVOLA	



Замовлення запчастин

(050)-407-68-47

(050)-407-68-45





ELECTROVANNE

ELEKTROSWITCH

ELEKTROWAHLSCHALTUNG

ELETTOINTERRUTTORE

Rep	Nr	Qt	Designation	Description	Bezeichnung	Referenza	Remarque - Remark - Bemerkung - Osservazioni
001	582548	001	SUPPORT	SUPPORT	TRAEGER	SUPPORTO	
002	80061036	002	VIS TETE HEXAGONALE FE/ZNXC3	HEXAGON HEAD SCREW FE/ZNXC3	SECHSKANTSCHRAUBE FE/ZNXC3	VITE TESTA ESAGONALE FE/ZNXC3	
003	80110806	002	VIS T.FRAI.SIX P.CR.FE/ZNXC3	HEX.SOC.COUNT.HEAD SC.FE/ZNXC3	SEKSKANTSCHRAUB INNENSEC.FE/ZNXC3	VITE FE/ZNXC3	
004	80201030	002	ECROU HEX.AUTOFREINE FE/ZNXC3	SELF-LOCKING NUT FE/ZNXC3	SELBSTSICH.MUTTER FE/ZNXC3	DADO AUTOBLOCCANTE FE/ZNXC3	
005	82300026	002	CAPUCHON COUPLEUR MALE	CAP MALE CONNECTOR	KAPPE KUPPLUNGSSTECKER	TAPPO	
006	A4074017	002	COUPLEUR MALE	CONNECTOR MALE	KUPPLUNGSTECKER	INNESTO M16X150	
007	A4080401	006	UNION MALE	MALE STUD CONNECTOR	GERADER EINSCHRAUBSTUTZEN	GIUZIONE DIRITTA ZBC	
008	A4921076	001	FLEXIBLE HYDRAULIQUE	HYDRAULIC HOSE	HYDRAULIKSCHLAUCH	TUBO GOMMA	<->1550 mm
009	A4921076	001	FLEXIBLE HYDRAULIQUE	HYDRAULIC HOSE	HYDRAULIKSCHLAUCH	TUBO GOMMA	<->1550 mm
010	H0601070	001	ELECTROVANNE	ELECTRIC SHUT-OFF SLIDE	ELEKTROSCHIEBER	ELETTOVALVOLA	
011	H0603930	001	BOITIER DE COMMANDE	CONTROL BOX	BEDIENKONSOLE	SCATOLA DI COMANDO	



Замовлення запчастин

(050)-407-68-47

(050)-407-68-45

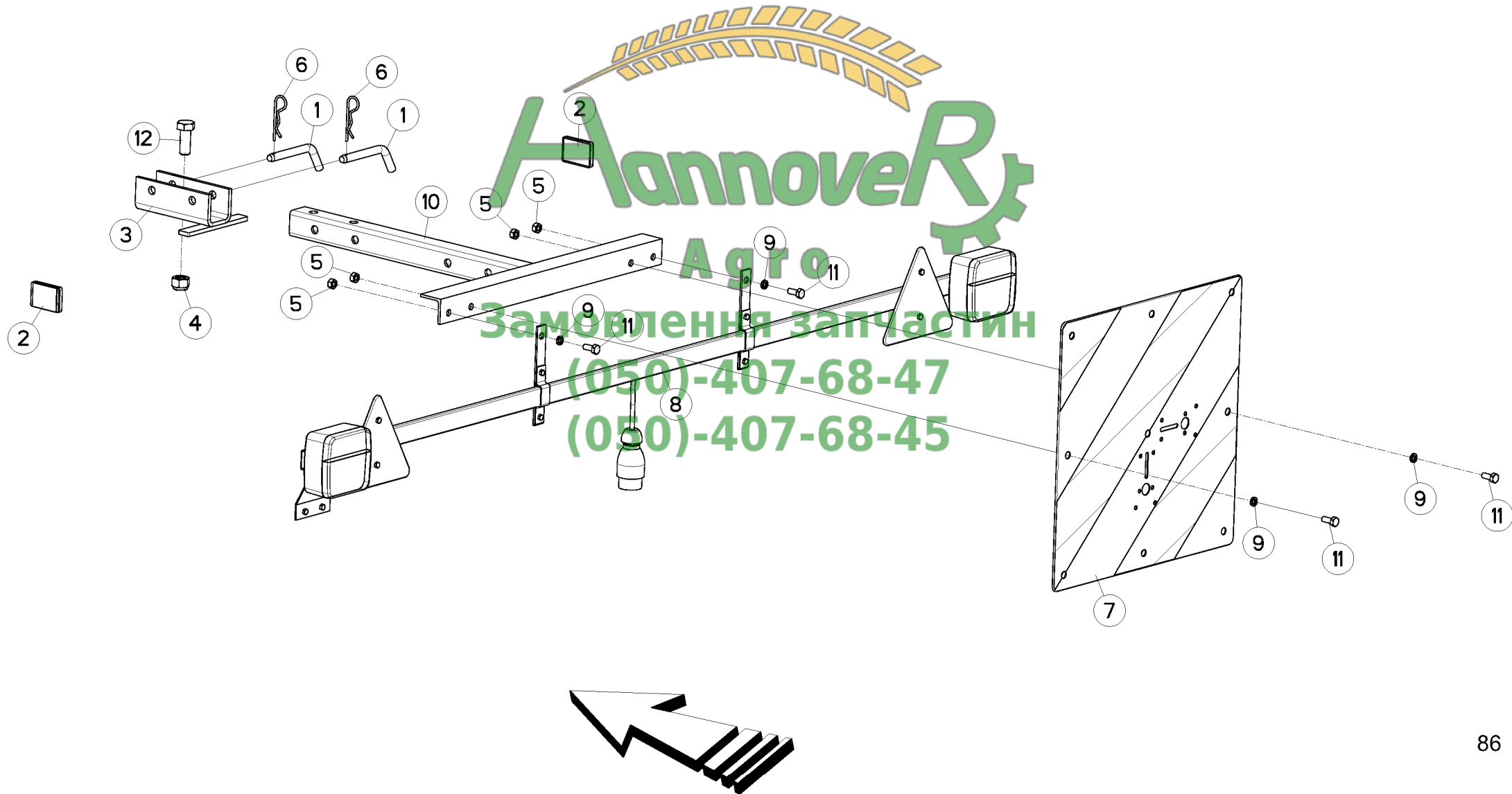



RAMPE DE SIGNALISATION T

T REAR LIGHTING BOARD

T HECKBELEUCHTUNG FÜR TRANSPOR IMPIANTO TRASPORTO

Rep	Nr	Qt	Designation	Description	Bezeichnung	Referenza	Remarque - Remark - Bemerkung - Osservazioni
001	140297	002	BROCHE DE VERROUILLAGE	PIN	ACHSE	PERNO	
002	83240017	002	CATADIOPTRE ORANGE ADHESIF	REFLECTOR ADHESIVE	RUECKSTRAHLER S.KLEB.	CATADIOTTRO	
003	582271	001	CHAPE	CLEVIS	GABEL	FORCELLA	
004	80201630	001	ECROU HEX.AUTOFREINE FE/ZNXC3	SELF-LOCKING NUT FE/ZNXC3	SELBSTSICH.MUTTER FE/ZNXC3	DADO AUTOBLOCCANTE FE/ZNXC3	
005	80200870	004	ECROU HEXAGONAL FE/ZNXC3	NUT FE/ZNXC3	SECHSKANTMUTTER FE/ZNXC3	DADO FE/ZNXC3	
006	80570300	002	GOUPILLE BETA SIMPLE FE/ZNXC3	SPRING COTTER PIN FE/ZNXC3	FEDERSTECKER FE/ZNXC3	MOLLA FE/ZNXC3	
007	83240212	001	PANNEAU CARRE SIMPLE-FACE	WARNING PLATE	WARNTAFEL	PANNELLO B/R ANT.	
008	83240406	001	RAMPE D'ECLAIRAGE	LIGHTING BOARD	HECKBELEUCHTUNG	IMP.SEGNALAZIONE	
009	80270803	004	RONDELLE GROWER FE/ZNXC3	SPRING LOCK WASHER FE/ZNXC3	FEDERRING FE/ZNXC3	RONDELLA GROWER FE/ZNXC3	
010	582270	001	SUPPORT DE RAMPE	BRACKET	HALTERUNG	SUPPORTO	
011	80060820	004	VIS TETE HEXAGONALE FE/ZNXC3	HEXAGON HEAD SCREW FE/ZNXC3	SECHSKANTSCHRAUBE FE/ZNXC3	VITE TESTA ESAGONALE FE/ZNXC3	
012	80061641	001	VIS TETE HEXAGONALE FE/ZNXC3	HEXAGON HEAD SCREW FE/ZNXC3	SECHSKANTSCHRAUBE FE/ZNXC3	VITE TESTA ESAGONALE FE/ZNXC3	



Замовлення запчастин

(050)-407-68-47

(050)-407-68-45



Замовлення запчастин
(050)-407-68-47
(050)-407-68-45



MULTI-LEADER T

C0000 >

H06R0078 B

FAISCEAU ELECTRIQUE SIGNALISAT

WIRING HARNESS SIGNALLING

KABELBAUM BELEUCHTUNG U.WARNTA CABLAGGIO SEGNALAZIONE

Rep	Nr	Qt	Designation	Description	Bezeichnung	Referenza	Remarque - Remark - Bemerkung - Osservazioni
001	80100560	003	VIS TETE CYL.FENDUE FE/ZNXC3	SLOT.CHEES.HEAD SCREW FE/ZNXC3	ZYLINDERSCHAU.SCHLITZ FE/ZNXC3	VITE TESTA CILINDR.FE/ZNXC3	
002	80200500	003	ECROU HEXAGONAL FE/ZNXC3	NUT FE/ZNXC3	SECHSKANTMUTTER FE/ZNXC3	DADO FE/ZNXC3	
003	80270584	003	RONDELLE GROWER FE/ZNXC3	SPRING LOCK WASHER FE/ZNXC3	FEDERRING FE/ZNXC3	RONDELLA GROWER FE/ZNXC3	
004	H0601230	001	ENSEMBLE	ASSEMBLY	SATZ	INSIEME	

**Замовлення запчастин****(050)-407-68-47****(050)-407-68-45**





COUPLEURS HYDRAULIQUES RUSSE

HYDRAULIC COUPLERS RUSSE

HYDRAULIKANSCHLUESSE RUSSE

CONNETTORI IDRAULICI RUSSE

Rep	Nr	Qt	Designation	Description	Bezeichnung	Referenza	Remarque - Remark - Bemerkung - Osservazioni
001	A4074001	001	COUPLEUR	COUPLER	KUPPLER	GIUNTO	
002	A4074000	001	COUPLEUR	COUPLER	KUPPLER	GIUNTO	
003	A4230021	001	BAGUE BS21	BUSH BS	BUCHSE BS	BOCCOLA	
004	951453	001	ADAPTATEUR	FITTING, HYDRAULIC, ADAPTER	ANBAUELEMENT	ADATTATORE	



Замовлення запчастин

(050)-407-68-47

(050)-407-68-45



Замовлення запчастин
(050)-407-68-47
(050)-407-68-45



ETIQUETTES ADHESIVES MLD T

STICKERS MLD T

AUFKLEBER MLD T

ADESIVI MLD T

Rep	Nr	Qt	Designation	Description	Bezeichnung	Referenza	Remarque - Remark - Bemerkung - Osservazioni
001	59900000	001	PICTOGR.H NOTICE D'INSTR	PICTORIAL H INSTRUCTIONS	PIKTOGR.H BETRIEBSANLEITUNG	ADESIVO	
002	59900400	001	PICTOGR.H ARRETER MOTEUR	PICTORIAL H STOP ENGINE	PIKTOGR.H MOTOR ABSTELLEN	ADESIVO	
003	59900300	002	PICTOGR.H ECRASEM.MAIN	PICTORIAL H CRUSH.DANGER HAND	PIKTOGR.H QUETSCHGEFAHR HAND	ADESIVO	
004	59900600	001	PICTOGR.H ECRASEM.TORSE	PICTORIAL H CRUSH.DANG.TORSO	PIKTOGR.H QUETSCHGEF.BRUSTK	ADESIVO	
005	59900500	001	PICTOGR.H ECRASEM.CORPS	PICTORIAL H CRUSH. DANGER BODY	PIKTOGR.H QUETSCHGEF.KOERPER	ADESIVO	
006	K9530260	002	ETIQ.ADH.	DECAL	AUFKLEBER	ADESIVO	
007	950333	001	AUTOCOL.POSITION RALLON.VERSOI	STICKER MDB EXTENSION	AUFKLEBER STREICHBLECHVERL.	ADESIVO	
008	950470	002	AUTOCOL.CROCHET LEVAGE	STICKER	AUFKLEBER	ADESIVO	
009	950414	014	AUTOCOL.POMPE A GRAISSE	STICKER OIL PUMP	AUFKLEBER SCHMIERUNG	ADESIVO	
010	K9530020	001	ETIQ.ADH.	DECAL	AUFKLEBER	ADESIVO	
011	09968300	001	ETIQ.ADHESIVE	TRANSFER MAX.25	AUFKLEBER MAX.25	ADESIVO LIMITE VELOC. MAX.25	
012	H0200830	001	ETIQ.ADH.	DECAL	AUFKLEBER	ADESIVO	
013	K9530270	002	ETIQ.ADH.	DECAL	AUFKLEBER	ADESIVO	
014	H0601290	001	AUTOCOLLANT VERROUILLAGE TRANS	STICKER	AUFKLEBER	ADESIVO	
015	K9500010	005	LOGO KUHN 103 BLANC/TRANSP.	LOGO KUHN 103	LOGO KUHN 103	LOGO KUHN 103 BIANCO TRASP	
016	K9500070	010	LOGO KUHN 207 BLANC/TRANSP.	LOGO KUHN 207	LOGO KUHN 207 WEISS/TRANSP.	LOGO KUHN 207 BIANCO TRASP.	
017	K9509110	002	ETIQ.ADH.	DECAL	AUFKLEBER	ADESIVO	
018	950219	001	AUTOCOL. INDEXAGE HYD	STICKER "HYDRAULIC INDEX"	AUFKLEBER	ADESIVO	
019	59901500	001	PICTOGR.H DANGER L.ELECTR	PICTORIAL H ELECTR.POWER LINE	PIKTOGR.H STROMLEITUNG	ADESIVO	
020	H0400450	001	AUTOCOLLANT -	STICKER	AUFKLEBER	ADESIVO	

Замовлення запчастин

(050)-407-68-47

(050)-407-68-45





SUPPORT (CLEE)

SUPPORT (KEY)

HALTERUNG (SCHLUSSEL)

SUPPORTO (##KEY)

Rep	Nr	Qt	Designation	Description	Bezeichnung	Referenza	Remarque - Remark - Bemerkung - Osservazioni
001	211664	001	CLE 30/36	SPANNER 30/36	SCHLUESSEL 30/36	CHIAVE	
002	80201030	002	ECROU HEX.AUTOFREINE FE/ZNXC3	SELF-LOCKING NUT FE/ZNXC3	SELBSTSICH.MUTTER FE/ZNXC3	DADO AUTOBLOCCANTE FE/ZNXC3	
003	541001	002	GOUILLE RAPIDE	LYNCH PIN D10 CAT2	KLAPPSTECKER D10 KAT2	CAPPIGLIA	
004	80251021	002	RONDELLE PLATE FE/ZNXC3	PLAIN WASHER FE/ZNXC3	SCHEIBE FE/ZNXC3	RONDELLA PIATTA FE/ZNXC3	
005	H0105070	002	SUPPORT	SUPPORT	TRAEGER	SUPPORTO	
006	80061020	002	VIS TETE HEXAGONALE FE/ZNXC3	HEXAGON HEAD SCREW FE/ZNXC3	SECHSKANTSCHRAUBE FE/ZNXC3	VITE A TESTA ESAGONALE FE/ZNXC	



Замовлення запчастин

(050)-407-68-47

(050)-407-68-45

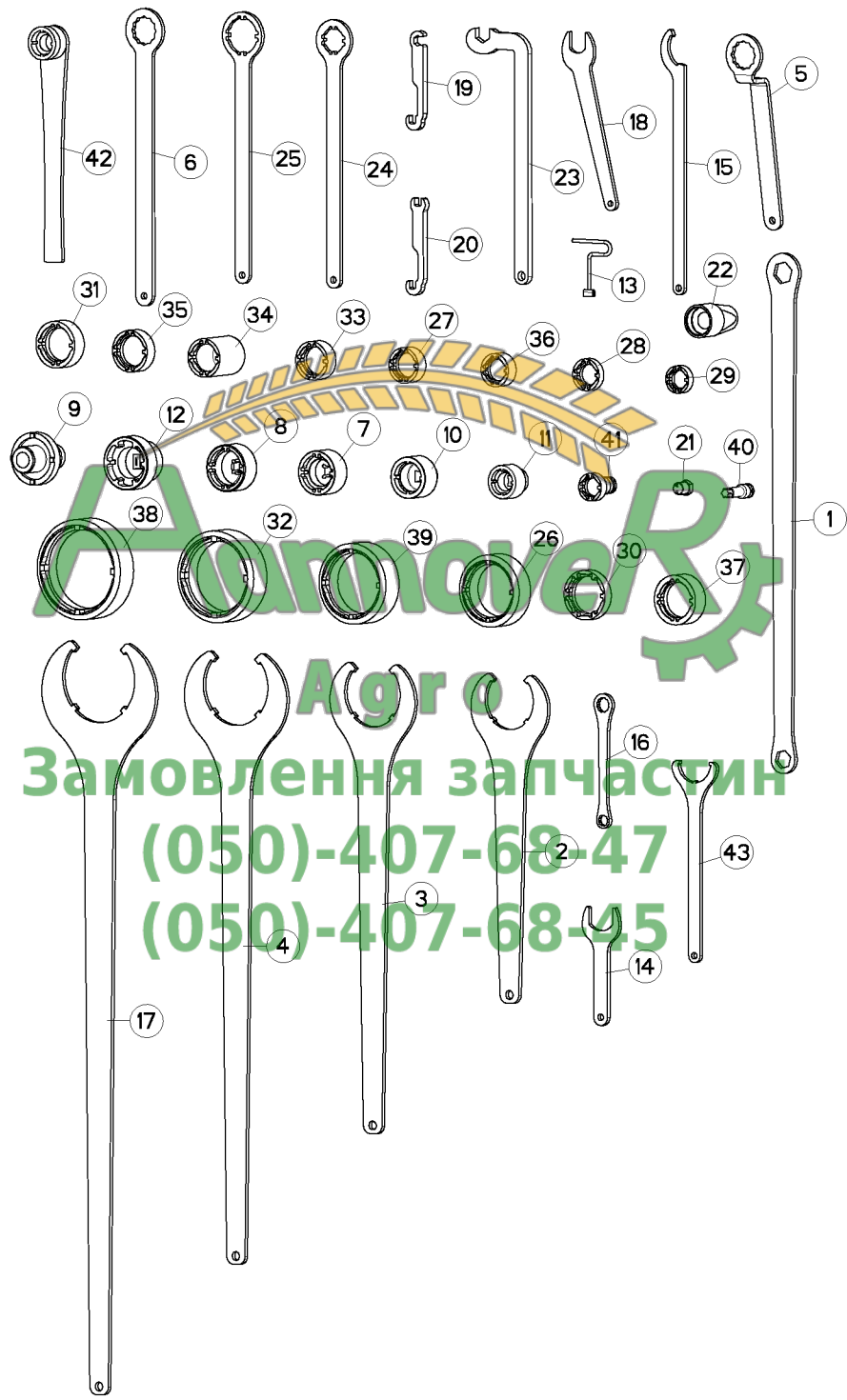



OUTILLAGE

TOOLS

WERKZEUG

ATTREZZI

Rep	Nr	Qt	Designation	Description	Bezeichnung	Referenza	Remarque - Remark - Bemerkung - Osservazioni
001	211664	001	CLE 30/36	SPANNER 30/36	SCHLUESSEL 30/36	CHIAVE	: M20 / M24
002	211828	001	CLE SPECIALE	SPANNER	SCHLUESSEL	CHIAVE	: KM M80 / 971101 / 80208018
003	211829	001	CLE SPECIALE	SPANNER	SCHLUESSEL	CHIAVE	: KM M90 / 951115
004	211830	001	CLE SPECIALE	SPANNER	SCHLUESSEL	CHIAVE	: KM M105 / 951180
005	381660	001	CLE CAMBRE A OEIL - 46/PLATS	SPANNER	SCHLUESSEL	CHIAVE	: M30, 80203031
006	780104	001	CLE A OEIL 46/PLATS	SPANNER 46	SCHLUESSEL	CHIAVE	: M30, 80203031
007	3104124	001	DOUILLE DE SERRAGE	SPECIAL SOCKET	SPEZIAL STECKNUSS	CHIAVE SPECIALE	: KM M10 / 80204519 / 80204566
008	3119467	001	DOUILLE	SOCKET	STECKNUSS	CHIAVE	: KM M50 / 50019600
009	3125420	001	DOUILLE->52502300	SPECIAL SOCKET->52502300	SPEZIAL STECKNUSS	CHIAVE SPECIALE	: 52502300
010	3125587	001	DOUILLE	ROUND	RUNDUNG	CHIAVE SPECIALE	: KM M40 / 80204063
011	3157109	001	DOUILLE SERR./ENCOCHES:M30X1,5	SPECIAL SOCKET->80203065	SPEZIAL STECKNUSS	CHIAVE SPECIALE	: KM M30 / 80203065
012	3177802	001	DOUILLE SERR./ENCOCHES:M55X2,0	SPECIAL SOCKET->80205519	SPEZIAL STECKNUSS	CHIAVE SPECIALE	: KM M55 / 80205519
013	52598210	001	CLE DEVER.GOUP.FIX.RAPIDE ZBC	WRENCH	SCHLUESSEL	CHIAVE FISSAGGIO FAST FIT	: M33 / H0201280
014	H0301420	001	CLE	WRENCH	SCHLUESSEL	CHIAVE	
015	H0333500	001	CLE A ERGOTS	SPANNER	SCHLUESSEL	CHIAVE	: KM M25 / H0333270
016	H0600040	001	CLE 18 / 24	SPANNER	SCHLUESSEL	CHIAVE	: M12 / M16
017	H0600770	001	CLE SPECIALE	SPANNER	SCHLUESSEL	CHIAVE	: KM M120 / 951813
018	H0600780	001	CLE SPECIALE	SPANNER	SCHLUESSEL	CHIAVE	: M22
019	H0600790	001	CLE SPECIALE	SPANNER	SCHLUESSEL	CHIAVE	: A4083100
020	H0600800	001	CLE SPECIALE	SPANNER	SCHLUESSEL	CHIAVE	: A4083100
021	H0600810	001	CLE BLOC POWER PACKER	SPANNER	SCHLUESSEL	CHIAVE	: BLOC POWER PACKER
022	H0600890	001	CENTREUR	TOOL, DRILL GUIDE	ZENTRIERSTUECK	CHIAVE	: H0206480, H0508350,...(80205566)
023	H0600960	001	CLE SPECIALE (CHAISE HX-1ER PR	SPANNER	SCHLUESSEL	CHIAVE	: M20 / 80202040
024	H0602770	001	CLE	WRENCH	SCHLUESSEL	CHIAVE	: KM M30 / 80203018
025	H0602780	001	CLE	WRENCH	SCHLUESSEL	CHIAVE	: KM M45 / 80204517
026	H0604340	001	CLE	WRENCH	SCHLUESSEL	CHIAVE	: KM M16 / 80208018
027	H0604420	001	CLE	WRENCH	SCHLUESSEL	CHIAVE	: 80203565
028	H0604430	001	CLE	WRENCH	SCHLUESSEL	CHIAVE	
029	H0604440	001	CLE	WRENCH	SCHLUESSEL	CHIAVE	: 80202566
030	H0604450	001	CLE	WRENCH	SCHLUESSEL	CHIAVE	: 80205566
031	H0604460	001	CLE	WRENCH	SCHLUESSEL	CHIAVE	: 80204566
032	H0604470	001	CLE	WRENCH	SCHLUESSEL	CHIAVE	: 951180
033	H0604480	001	CLE	WRENCH	SCHLUESSEL	CHIAVE	: 80204063
034	H0604490	001	CLE	WRENCH	SCHLUESSEL	CHIAVE	: 80204063
035	H0604500	001	CLE	WRENCH	SCHLUESSEL	CHIAVE	: 80204566
036	H0604510	001	CLE	WRENCH	SCHLUESSEL	CHIAVE	: 80203066
037	H0604520	001	CLE	WRENCH	SCHLUESSEL	CHIAVE	: 80205018
038	H0604530	001	CLE	WRENCH	SCHLUESSEL	CHIAVE	: 951813
039	H0604540	001	CLE	WRENCH	SCHLUESSEL	CHIAVE	: 951115
040	H0605310	001	DOUILLE	SOCKET	STECKNUSS	CHIAVE	: 50079100
041	H2219020	001	EMBOUT	END PIECE	ENDSTUECK	GIUNTO	: KM M25 / 80202566
042	H2400640	001	CLE SPECIALE (POUR ECROU MCR 3	SPANNER	SCHLUESSEL	CHIAVE	: KM30 / 80203066
043	H2413430	001	CLE	WRENCH	SCHLUESSEL	CHIAVE	: KM50 / 80205018

(050)-407-68-47

(050)-407-68-45



INDEX NUMERIQUE - NUMERICAL INDEX

TEILENUMMERN-INDEX - INDICE NUMERICO

Nr	Page	Rep.	Nr	Page	Rep.	Nr	Page	Rep.	Nr	Page	Rep.	Nr	Page	Rep.	Nr	Page	Rep.	Nr	Page	Rep.	Nr	Page	Rep.
A4050003	081	010	A4080411	053	019	A4921076	075	034	A7200102	043	023	H0104010	025	010	H0205000	019	023	H0206670	021	026	H0500590	079	015
A4050005	081	011	A4080429	049	015	A4921076	083	010	A7200102	045	026	H0104010	027	001	H0205000	021	021	H0206670	023	026	H0500740	081	029
A4061501	081	012	A4080429	051	019	A4921076	083	011	A7250558	013	011	H0104010	075	038	H0205010	075	040	H0206970	043	025	H0502780	055	001
A4061504	081	012	A4080429	053	020	A4921076	085	008	A7260027	073	036	H0104020	041	034	H0205020	017	024	H0206970	045	028	H0502790	055	002
A4061802	081	013	A4080429	081	018	A4921076	085	009	A7260029	029	007	H0104021	013	003	H0205020	019	024	H0206970	047	025	H0502800	055	003
A4061802	083	007	A4080429	081	020	A4921098	033	023	A7260029	033	014	H0104240	043	024	H0205020	021	022	H0207030	035	012	H0502810	055	004
A4061803	081	014	A4080430	023	013	A4921098	033	024	A7260029	049	019	H0104240	045	027	H0205090	075	041	H0207030	037	011	H0505030	043	026
A4061815	049	010	A4080430	049	016	A4921101	033	025	A7260029	051	024	H0104240	047	024	H0205100	075	042	H0207040	035	013	H0505030	043	039
A4061815	051	013	A4080430	051	020	A4921101	033	026	A7260029	053	027	H0104710	011	035	H0205110	073	039	H0207040	037	012	H0505030	045	029
A4061815	053	013	A4080430	053	021	A4921102	023	019	H0100170	011	026	H0104711	013	014	H0205110	075	043	H0207360	075	044	H0505030	045	042
A4071207	081	015	A4080502	049	017	A4921102	023	020	H0100170	013	009	H0105070	095	005	H0205770	033	027	H0208220	075	045	H0505030	047	026
A4071228	075	027	A4080513	023	014	A4921110	081	023	H0100350	011	027	H0105090	013	025	H0205780	033	028	H0208660	015	005	H0505030	047	042
A4072010	049	011	A4080513	051	021	A4921110	081	024	H0100350	013	030	H0105120	075	039	H0205960	033	029	H0208670	015	006	H0505060	057	001
A4072010	051	014	A4080513	053	022	A4921115	081	024	H0100350	017	016	H0200830	093	012	H0205970	031	005	H0208680	015	007	H0505070	057	002
A4072010	053	014	A4080702	053	023	A4922070	053	028	H0100350	019	016	H0202840	039	018	H0205980	031	006	H0208690	015	008	H0505080	057	003
A4074000	091	002	A4080750	023	015	A4923011	049	020	H0100350	021	016	H0204720	017	018	H0205990	031	007	H0208700	015	009	H0505130	043	027
A4074001	091	001	A4080750	033	012	A4923011	051	025	H0100350	025	009	H0204720	019	018	H0206040	017	025	H0208710	015	010	H0505130	045	030
A4074017	033	009	A4080751	053	024	A4923011	053	029	H0100350	027	011	H0204740	017	019	H0206040	019	025	H0208730	021	027	H0505130	047	027
A4074017	085	006	A4081304	049	018	A4923014	081	023	H0100350	075	035	H0204740	019	019	H0206040	021	023	H0208800	021	028	H0505130	049	028
A4074018	023	009	A4081304	051	022	A4923015	049	021	H0100630	003	004	H0204740	021	018	H0206040	023	024	H0208810	027	012	H0505130	051	034
A4074018	049	012	A4081304	053	025	A4923015	049	022	H0100630	005	004	H0204740	023	023	H0206080	033	030	H0208810	033	031	H0505130	053	039
A4074018	051	015	A4082615	023	016	A4923015	051	026	H0100630	007	008	H0204780	017	020	H0206290	011	036	H0208810	053	038	H0505160	049	029
A4074018	053	015	A4082700	075	030	A4923015	051	027	H0100630	009	004	H0204780	019	020	H0206290	013	008	H0208830	021	030	H0505160	051	035
A4074018	081	016	A4082732	051	023	A4923015	053	030	H0101220	003	005	H0204780	021	019	H0206300	011	037	H0208840	021	031	H0505160	053	040
A4075005	023	010	A4082732	053	026	A4923015	053	031	H0101220	005	005	H0204830	029	008	H0206300	013	004	H0301420	097	014	H0505180	043	028
A4075005	049	013	A4083100	081	021	A4923030	049	023	H0101220	009	005	H0204840	025	011	H0206390	035	008	H0302300	013	006	H0505180	045	031
A4075005	051	016	A4083102	081	021	A4923030	051	028	H0101750	007	009	H0204840	027	007	H0206390	037	007	H0333500	097	015	H0505690	059	006
A4075005	053	016	A4101036	081	022	A4923030	053	032	H0101760	007	010	H0204850	039	019	H0206400	035	009	H0400320	061	004	H0505700	059	007
A4080300	033	010	A4230021	091	003	A4923031	081	025	H0102980	003	006	H0204870	039	020	H0206400	037	008	H0400450	093	020	H0505710	059	008
A4080300	073	032	A4921014	033	013	A4923035	081	026	H0102990	005	006	H0204880	039	021	H0206410	035	010	H0405470	063	014	H0505730	059	009
A4080302	075	028	A4921014	073	035	A4923035	081	027	H0103000	007	011	H0204890	041	004	H0206410	037	009	H0405470	065	015	H0507110	043	029
A4080306	049	014	A4921014	075	031	A4923036	081	025	H0103010	011	028	H0204901	039	022	H0206440	035	011	H0405480	063	015	H0507110	045	032
A4080306	051	017	A4921014	075	032	A4923045	049	024	H0103011	013	001	H0204910	025	012	H0206440	037	010	H0405480	065	016	H0507110	047	028
A4080306	053	017	A4921019	023	017	A4923045	051	029	H0103020	075	036	H0204910	027	008	H0206480	017	026	H0405510	063	016	H0507130	043	030
A4080315	053	018	A4921019	023	018	A4923045	053	033	H0103030	075	037	H0204920	025	013	H0206480	019	026	H0405510	065	017	H0507130	045	033
A4080350	073	033	A4921023	033	015	A4923047	023	021	H0103470	011	029	H0204921	027	010	H0206480	021	024	H0405520	063	017	H0507130	047	029
A4080401	023	011	A4921023	033	016	A4923047	023	022	H0103471	013	031	H0204940	017	021	H0206620	029	009	H0405520	065	018	H0507140	043	031
A4080401	033	011	A4921023	033	017	A4923047	049	025	H0103600	011	030	H0204940	019	021	H0206630	029	010	H0405940	061	005	H0507150	043	032
A4080401	073	034	A4921023	033	018	A4923047	051	030	H0103610	011	031	H0204960	039	023	H0206630	051	033	H0405950	061	006	H0507250	043	033
A4080401	075	029	A4921042	033	019	A4923047	053	034	H0103780	011	032	H0204970	039	024	H0206630	053	037	H0500480	079	008	H0507250	045	034
A4080401	081	018	A4921042	033	020	A4923048	053	035	H0103781	013	015	H0204980	017	030	H0206650	017	027	H0500490	079	009	H0507250	047	030
A4080401	083	009	A4921054	073	037	A4923066	049	026	H0104010	011	033	H0204980	019	030	H0206650	019	027	H0500500	079	010	H0507280	043	034
A4080401	085	007	A4921066	073	038	A4923066	051	031	H0104010	013	002	H0204990	017	022	H0206650	021	025	H0500510	079	011	H0507280	045	035
A4080402	023	012	A4921069	033	021	A4923070	051	032	H0104010	017	017	H0204990	019	022	H0206650	023	025	H0500520	079	012	H0507280	047	031
A4080402	081	019	A4921069	033	022	A4923076	049	027	H0104010	019	017	H0204990	021	020	H0206670	017	028	H0500530	079	013	H0507290	043	035
A4080411	051	018	A4921076	075	033	A4923077	053	036	H0104010	021	017	H0205000	017	023	H0206670	019	028	H0500580	079	014	H0507290	045	036



INDEX NUMERIQUE - NUMERICAL INDEX

TEILENUMMERN-INDEX - INDICE NUMERICO

Nr	Page	Rep.	Nr	Page	Rep.	Nr	Page	Rep.	Nr	Page	Rep.	Nr	Page	Rep.	Nr	Page	Rep.	Nr	Page	Rep.	Nr	Page	Rep.
H0507290	047	032	H0603930	085	011	140297	087	001	582216	067	003	80060826	081	002	80061291	013	043	80110806	085	003	80201240	047	011
H0507340	043	036	H0604000	063	011	194106	073	003	582262	073	007	80060830	053	005	80061296	017	005	80111029	069	015	80201601	067	007
H0507340	045	037	H0604000	065	012	211228	073	004	582270	087	010	80060834	081	003	80061296	019	005	80111029	071	014	80201630	087	004
H0507350	043	037	H0604340	097	026	211664	095	001	582271	087	003	80060853	075	008	80061296	021	005	80131018	013	035	80201640	011	017
H0507350	045	038	H0604420	097	027	211664	097	001	582519	075	001	80060864	075	009	80061296	023	004	80151635	067	006	80201640	013	021
H0507350	047	033	H0604430	097	028	211817	069	005	582538	073	008	80061018	041	008	800616C2	063	012	80190616	013	036	80201640	059	002
H0507370	043	038	H0604440	097	029	211817	071	004	582539	073	009	80061020	095	006	800616C2	065	003	80190616	043	007	80201640	063	004
H0507370	045	039	H0604450	097	030	211828	097	002	582548	083	001	80061036	083	004	80061638	069	013	80190616	045	009	80201640	065	005
H0507370	047	034	H0604460	097	031	211829	097	003	582548	085	001	80061036	085	002	80061638	071	012	80200440	043	008	80201669	063	005
H0508300	045	040	H0604470	097	032	211830	097	004	582700	069	009	80061040	047	003	80061641	087	012	80200440	045	010	80201669	065	006
H0508300	047	035	H0604480	097	033	212239	045	001	582700	071	008	80061054	017	003	80061647	067	004	80200500	089	002	80201670	067	008
H0508310	045	041	H0604490	097	034	212239	047	001	582701	069	010	80061054	019	003	80061651	011	013	80200540	043	009	80201670	069	017
H0508310	047	036	H0604500	097	035	261166	067	001	582701	071	009	80061054	021	003	80061651	013	041	80200540	045	011	80201670	071	016
H0509440	047	037	H0604510	097	036	3104124	097	007	582742	075	002	80061066	013	038	80061651	059	001	80200830	075	014	80202030	069	018
H0509450	047	038	H0604520	097	037	3119467	097	008	583707	073	010	80061066	075	010	80062049	039	005	80200830	081	007	80202030	071	017
H0509460	047	039	H0604530	097	038	3125420	097	009	583710	073	011	80061073	047	004	80062067	027	014	80200840	043	010	80202030	073	020
H0509540	047	040	H0604540	097	039	3125587	097	010	59900000	093	001	80061073	049	004	80062067	039	006	80200840	045	012	80202040	073	021
H0509560	047	041	H0605310	097	040	3157109	097	011	59900300	093	003	80061073	051	006	80062067	041	001	80200840	047	009	80202047	025	005
H0600040	097	016	H2207650	017	029	3177802	097	012	59900400	093	002	80061073	053	006	80062068	025	003	80200840	075	015	80202047	027	005
H0600090	081	030	H2207650	019	029	381660	097	005	59900500	093	005	80061090	043	004	80062068	027	015	80200870	087	005	80202047	029	004
H0600100	081	028	H2207650	021	029	421138	007	002	59900600	093	004	80061090	045	005	80062068	029	003	80201001	013	023	80202047	039	009
H0600140	049	030	H2219020	097	041	421223	039	001	59901500	093	019	80061090	047	005	80062076	063	003	80201030	011	015	80202047	041	002
H0600140	051	036	H2400640	097	042	421223	061	001	645280	063	002	80061225	011	010	80062076	065	004	80201030	017	006	80202069	025	006
H0600140	053	041	H2413430	097	043	422069	067	002	645317	069	011	80061225	013	039	80062080	073	015	80201030	019	006	80202069	027	006
H0600650	013	017	H2417650	013	034	432023	069	006	645317	071	010	80061225	033	004	80062084	039	007	80201030	021	006	80202069	029	005
H0600770	097	017	K2502911	011	038	432023	071	005	731018	013	013	80061226	011	011	80062479	073	016	80201030	043	011	80202069	039	010
H0600780	097	018	K3606570	033	032	445424	063	001	750753	081	001	80061236	015	001	80062480	043	006	80201030	045	013	80202069	041	003
H0600790	097	019	K7024100	011	039	445424	065	001	780104	097	006	80061241	035	001	80062480	045	008	80201030	047	010	80202070	063	006
H0600800	097	020	K7024100	013	010	445475	073	005	780113	075	003	80061241	037	001	80062480	047	008	80201030	069	016	80202070	065	007
H0600810	097	021	K9500010	093	015	445476	073	006	780340	075	004	80061245	011	012	80062483	075	013	80201030	071	015	80202402	069	019
H0600890	097	022	K9500070	093	016	445556	007	003	80060416	043	002	80061245	013	040	80062484	039	008	80201030	075	016	80202402	071	018
H0600960	097	023	K9509110	093	017	445556	011	002	80060416	045	003	80061245	017	004	80062487	073	017	80201030	083	006	80202421	061	003
H0601070	083	012	K9530020	093	010	445556	013	024	80060518	043	003	80061245	019	004	80062489	011	014	80201030	085	004	80202421	069	020
H0601070	085	010	K9530260	093	006	445609	011	003	80060518	045	004	80061245	021	004	80062489	013	042	80201030	095	002	80202421	071	019
H0601170	075	046	K9530270	093	013	445609	013	018	80060612	011	007	80061245	025	002	80062494	007	005	80201230	075	017	80202442	007	006
H0601180	075	047	09968300	093	011	493115	039	002	80060612	013	037	80061245	027	013	80062498	073	018	80201240	011	016	80202442	011	018
H0601190	075	048	110029	069	001	52598210	097	013	80060612	029	001	80061245	035	002	80080530	081	004	80201240	013	020	80202442	013	022
H0601200	077	049	110030	069	002	541001	003	001	80060612	051	003	80061245	037	002	80080555	081	005	80201240	015	002	80202442	039	011
H0601210	077	050	110031	071	001	541001	005	001	80060612	053	003	80061245	075	011	80080570	081	006	80201240	017	007	80202442	073	022
H0601220	077	051	130170	069	003	541001	009	001	80060635	029	002	80061249	075	012	80080626	049	005	80201240	019	007	80202447	043	013
H0601230	089	004	130170	071	002	541001	017	001	80060635	033	003	80061250	045	006	80080626	051	007	80201240	021	007	80202447	045	015
H0601290	093	014	130276	007	001	541001	095	003	80060635	051	004	80061250	047	006	80080626	053	007	80201240	023	005	80202447	047	012
H0602340	073	040	130314	069	004	581960	069	007	80060635	053	004	80061255	043	005	80080626	073	019	80201240	025	004	80202447	073	023
H0602350	073	041	130314	071	003	581961	069	008	80060820	023	003	80061255	045	007	80091640	067	005	80201240	027	004	80202447	075	018
H0602360	073	042	130342	073	001	581962	071	006	80060820	049	003	80061255	047	007	80091640	069	014	80201240	035	003	80202566	069	021
H0602760	039	025	131036	073	002	581963	071	007	80060820	051	005	80061271	031	001	80091640	071	013	80201240	037	003	80202566	071	020
H0602770	097	024	139113	011	001	582196	065	002	80060820	075	007	80061271	033	005	80100560	089	001	80201240	043	012	80202720	063	007
H0602780	097	025	139113	013	012	582197	065	013	80060820	087	011	80061291	011	009	80110806	083	005	80201240	045	014	80202720	065	008



INDEX NUMERIQUE - NUMERICAL INDEX TEILENUMMERN-INDEX - INDICE NUMERICO

Nr	Page	Rep.	Nr	Page	Rep.	Nr	Page	Rep.	Nr	Page	Rep.	Nr	Page	Rep.	Nr	Page	Rep.	Nr	Page	Rep.
80202731	063	008	80252432	045	019	80451061	017	011	82201016	039	017	950414	093	009						
80202731	065	009	80252432	047	016	80451061	019	011	82201016	043	021	950470	093	008						
80203003	031	002	80252432	069	022	80451061	021	011	82201016	045	024	951166	069	012						
80203018	079	003	80252432	071	021	80451061	035	005	82201016	047	022	951166	071	011						
80203030	073	024	80252640	059	004	80451061	037	005	82201016	063	010	951184	073	012						
80203047	073	025	80253034	073	026	80471000	043	020	82201016	065	011	951185	073	031						
80203047	075	019	80253556	017	010	80471000	045	022	82201016	069	027	951197	073	013						
80204517	043	014	80253556	019	010	80471000	047	019	82201016	071	026	951209	023	001						
80204517	045	016	80253556	021	010	80500470	015	004	82201016	073	030	951211	033	001						
80204517	047	013	80270584	089	003	80500780	017	012	82201016	075	026	951212	049	001						
80204518	017	008	80270605	011	020	80500780	019	012	82300026	023	007	951212	051	001						
80204518	019	008	80270605	013	032	80500780	021	012	82300026	033	006	951212	053	001						
80204518	021	008	80270803	023	006	80561760	003	003	82300026	049	008	951408	019	001						
80204566	039	012	80270803	049	006	80561760	005	003	82300026	051	009	951408	021	001						
80205566	011	019	80270803	051	010	80561760	007	007	82300026	053	009	951409	023	002						
80205566	013	019	80270803	053	010	80561760	009	003	82300026	081	017	951409	033	002						
80205566	017	009	80270803	075	025	80570201	047	020	82300026	083	008	951409	049	002						
80205566	019	009	80270803	081	009	80570300	011	022	82300026	085	005	951409	051	002						
80205566	021	009	80270803	087	009	80570300	013	026	83013539	017	015	951409	053	002						
80205566	025	007	80271003	049	007	80570300	087	006	83013539	019	015	951430	073	014						
80205566	027	003	80271003	051	011	80570477	043	019	83013539	021	015	951448	011	005						
80205566	075	020	80271003	053	011	80570477	045	023	83014043	043	022	951448	013	007						
80208018	039	013	80271203	031	003	80570477	047	021	83014043	045	025	951448	075	005						
80250611	029	006	80271203	033	007	80570477	073	028	83014043	047	023	951453	091	004						
80250611	051	008	80271686	067	009	80581200	035	006	83070064	011	025	951521	011	006						
80250611	053	008	80271686	069	023	80583500	017	013	83070064	013	029	951521	017	002						
80250823	075	021	80271686	071	022	80583500	019	013	83090093	023	008	951521	019	002						
80250823	081	008	80272002	063	013	80583500	021	013	83090093	033	008	951521	021	002						
80251021	043	015	80272002	065	014	80595200	069	025	83090093	049	009	951521	025	001						
80251021	045	017	80283680	063	009	80595200	071	024	83090093	051	012	951521	027	002						
80251021	047	014	80283680	065	010	81302552	069	026	83090093	053	012	951521	039	004						
80251021	075	022	80293020	079	004	81302552	071	025	83090596	011	024	951521	043	001						
80251021	095	004	80294519	043	017	81303072	079	005	83090596	013	016	951521	045	002						
80251221	013	033	80294519	045	020	81304079	079	006	83240017	087	002	951521	047	002						
80251227	035	004	80294519	047	017	81309613	039	015	83240212	087	007	951521	075	006						
80251227	037	004	80298020	039	014	82158501	039	016	83240406	087	008	951637	083	002						
80251227	075	023	80440860	069	024	82200600	079	007	900155	079	001	951669	061	002						
80251336	045	018	80440860	071	023	82200616	073	029	900156	079	002	952251	083	003						
80251336	047	015	80441270	043	018	82201016	011	023	900742	011	004									
80251624	059	003	80441270	045	021	82201016	013	028	900742	013	005									
80251624	075	024	80441270	047	018	82201016	017	014	900769	039	003									
80252026	015	003	80450499	073	027	82201016	019	014	900788	007	004									
80252432	003	002	80450650	011	021	82201016	021	014	950219	035	007									
80252432	005	002	80450650	013	027	82201016	025	008	950219	037	006									
80252432	009	002	80450928	067	010	82201016	027	009	950219	093	018									
80252432	043	016	80451040	059	005	82201016	031	004	950333	093	007									

EXTRAIT DES CONDITIONS DE GARANTIE ET CONDITIONS SPECIFIQUES PIECES DE RECHANGE

Nous garantissons notre matériel durant une année à partir du jour de livraison, c'est-à-dire que nous nous engageons à rembourser les pièces qui auront été reconnues défectueuses en nos usines, par notre service technique.

Bien entendu, la garantie ne s'applique pas en cas d'usure normale, ni en cas de détériorations résultant de négligences ou de défauts de surveillance, d'un mauvais usage, d'un manque d'entretien ou d'un accident. La garantie ne s'applique pas non plus si la machine a été prêtée ou utilisée pour un usage non conforme à sa destination prévue par la société.

La garantie ne s'applique pas aux pièces d'usure.

Les pièces de rechange sont soumises aux mêmes conditions de garantie que le matériel sous réserve qu'elles aient été montées selon les règles de l'art et utilisées conformément à nos recommandations.

EXTRACT FROM OUR CONDITIONS OF LIMITED WARRANTY AND SPARE PARTS WARRANTY POLICY

Our equipment is warranted for a period of one year from the date of delivery. We guarantee the reimbursement of all parts proven to be faulty by our technical division in material or manufacturing.

The warranty is not applicable in the following cases : normal wear, accident or negligence in operation, repairs using parts other than genuine KUHN parts, products altered or modified without the expressed permission of the company or if the machine is not used and serviced in accordance with the recommendations of the operator's manual. Wearing items are not covered under these conditions of limited warranty.

Spare parts are subject to the same warranty conditions than the equipment providing they have been installed with proficiency and are used in accordance with our recommendations.

AUSZUG AUS UNSEREN GARANTIEBEDINGUNGEN UND SONDERBEDINGUNGEN FÜR ERSATZTEILE

Wir garantieren unsere Ware für ein Jahr ab dem Tag der Lieferung und verpflichten uns, die Teile zu ersetzen, die im Werk als fehlerhaft anerkannt wurden.

Die Garantie ist ausgeschlossen für Teile, die einem normalen Verschleiß unterliegen, sowie im Fall von nachlässiger Behandlung oder mangelhafter Wartung oder eines Unfalls. Die Garantie erlischt auch, wenn die Maschine ausgeliehen oder unter Umständen eingesetzt wurde, die dem ursprünglichen Verwendungszweck und den Hinweisen in der Betriebsanleitung nicht entsprechen.

Verschleißteile sind von der Garantie ausgeschlossen

Ersatzteile unterliegen den gleichen Garantiebedingungen wie komplette Maschinen, vorausgesetzt, dass sie sachgerecht eingebaut und entsprechend unseren Empfehlungen verwendet wurden.

ESTRATTO DELLE CONDIZIONI DI GARANZIA E CONDIZIONI SPECIFICHE GARANZIA RICAMBI

Le nostre macchine sono garantite per un anno a partire dal giorno della consegna: ci impegnamo a rimborsare i componenti che saranno riconosciuti difettosi dai nostri servizi tecnici presso le nostre officine.

La garanzia non è applicabile nei seguenti casi: usura normale, incidente o negligenza nell'impiego, riparazioni utilizzando ricambi non originali KUHN, prodotti alterati o modificati senza il permesso dell'azienda. La garanzia non viene riconosciuta se la macchina è stata prestata o non è utilizzata o mantenuta in conformità alle raccomandazioni previste dalla società. La garanzia non copre i componenti soggetti ad usura.

I pezzi di ricambio sono soggetti agli stessi termini di garanzia della macchina, purchè siano stati installati con competenza e utilizzati conformemente alle nostre raccomandazioni.

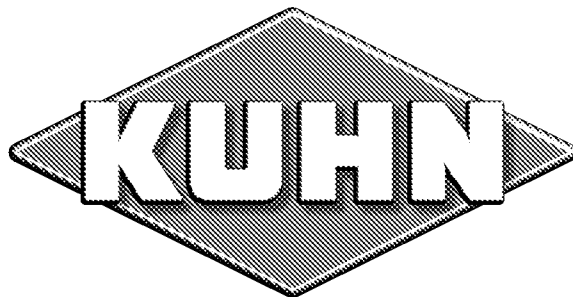

**Pour votre sécurité et le bon fonctionnement de votre machine,
utilisez uniquement des pièces d'origine KUHN**

**For your safety and to get the best from your machine,
use only genuine KUHN parts**

**Zu ihrer Sicherheit und zur einwandfreien Funktion Ihrer
Maschine sollten Sie nur Original-KUHN-Ersatzteile verwenden**

**Per la vostra sicurezza, e per il buon funzionamento della vostra macchina,
usate esclusivamente i ricambi originali KUHN**

**KUHN PARTS Parc de la Faisanderie F - 67700 MONSWILLER (FRANCE)
www.kuhn.com**

Imprimé en France par KUHN
Printed in France by KUHN